

Learning about the Constitution of the Republic of South Africa (1996)

The Constitution of South Africa (1996) is the highest law in the country. This law is higher than the President, higher than the courts and higher than the government.

It describes how the people of our country should treat each other, and what their rights and responsibilities are. The constitution of a country is there to protect all of us now, and our children in the future.

Be aware of our past.

Let us not repeat the mistakes of past.

Our Constitution helps us to imagine and build a better future for all.

We, the people of South Africa;
 Recognise the injustices of our past;
 Honour those who suffered for justice and freedom in our land;
 Respect those who have worked to build and develop our country; and
 Believe that South Africa belongs to all who live in it, united in our diversity.
 We therefore, through our freely elected representatives, adopt this Constitution as law of the Republic so as to—
 Heal the division of the past and establish a society based on democratic values, social justice and fundamental human rights;
 Lay the foundations for a democratic and open society in which government is based on the will of the people and every citizen is equally protected by law;
 Improve the quality of life of all citizens and free the potential of each person; and
 Build a united and democratic South Africa able to take its rightful place as a Sovereign state in the family of nations.



Claim your rights as a South African and be responsible to protect the rights of others.

Know your Bill of rights & Bill of Responsibilities.

May God protect our people.

Nkosi Sikelel' iAfrika. Morena boloka setjhaba sa heso.

God seën Suid-Afrika. God bless South Africa.

Mudzimu fhatutshedza Afurika. Hosi katekisa Afrika.



**MATHEMATICS IN ENGLISH
 GRADE 1 – BOOK 1**

TERMS 1 & 2

ISBN 978-1-920458-82-9

THIS BOOK MAY NOT BE SOLD.

9th Edition



MATHEMATICS IN ENGLISH – Grade 1 Book 1

ISBN 978-1-920458-82-9

**Revised and
 CAPS aligned**



Grade 1

Name: _____

Class: _____



basic education

Department:
 Basic Education
 REPUBLIC OF SOUTH AFRICA

MATHEMATICS IN ENGLISH

*Book 1
 Terms 1 & 2*

Contents

No.	Title	Pg.
1	Revision: Tracking and matching	2
2	Revision: Sorting colours and tracing patterns	4
3	Revision: Colours and patterns	6
4	Revision: Sorting and matching shapes	8
5	Revision: Find and count	10
6	Revision: Positions	12
7	Revision: Time	14
8	Revision: Shapes, sizes and colours	16
9	One	18
10	Two	20
11	Three	22
12a	Length and position	24
12b	Length	26
13	Compare numbers 1 to 3	28
14	Four	30
15	Add and subtract up to 4	32
16	Time	34
17	Five	36
18	Revise numbers 1 to 5	38
19	Add up to 5	40
20	Subtract from 5 and add up to 5	42
21	Add and subtract up to 5	44
22	Addition and subtraction 1 to 5	46
23	Balls and boxes	48
24a	Left and right	50
24b	Direction	52
25	Building up and breaking down numbers	54
26	Addition doubles	56
27	Bigger and smaller	58
28	Sort objects	60
29	Let us share equally	62
30	Sharing and grouping	64
31	Building objects	66
32	Telling time	68

No.	Title	Pg.
33	Six	70
34	Seven	72
35	Eight	74
36	Nine	76
37	Full or empty	78
38	Ten	80
39	Numbers 1 to 10	82
40	Capacity and volume	84
41	Number 1 to 10	86
42	More, equal and less	88
43	Adding	90
44	Collecting and organising	92
45	Addition to 10: counting on	94
46	Addition: building and breaking to 10	96
47	Doubling and halving	98
48a	Shapes	100
48b	More 2-D shapes	102
49	Groups of two to 10	104
50	Repeated addition of twos up to 10	106
51	Patterns: 2 to 20	108
52	Groups of three up to 10	110
53	Repeated addition of threes to 10	112
54	Groups of four up to 10	114
55	Repeated addition of fours up to 10	116
56	Groups of five up to 10	118
57	Repeated addition of fives up to 10	120
58	Five patterns to 20	122
59	Tens patterns	124
60a	Numbers and money	126
60b	Numbers and money (continued)	128
61	Money and change	130
62	More money and change	132
63	Shape, orientation and position	134
64a	Patterns with geometric shapes	136
64b	2-D shapes and 3-D objects	138



Mrs Angie Motshekga,
Minister of Basic
Education



Mr Enver Surty,
Deputy Minister
of Basic Education

These workbooks have been developed for the children of South Africa under the leadership of the Minister of Basic Education, Mrs Angie Motshekga, and the Deputy Minister of Basic Education, Mr Enver Surty.

The Rainbow Workbooks form part of the Department of Basic Education's range of interventions aimed at improving the performance of South African learners in the first six grades. As one of the priorities of the Government's Plan of Action, this project has been made possible by the generous funding of the National Treasury. This has enabled the Department to make these workbooks, in all the official languages, available at no cost.

We hope that teachers will find these workbooks useful in their everyday teaching and in ensuring that their learners cover the curriculum. We have taken care to guide the teacher through each of the activities by the inclusion of icons that indicate what it is that the learner should do.

We sincerely hope that children will enjoy working through the book as they grow and learn, and that you, the teacher, will share their pleasure.

We wish you and your learners every success in using these workbooks.

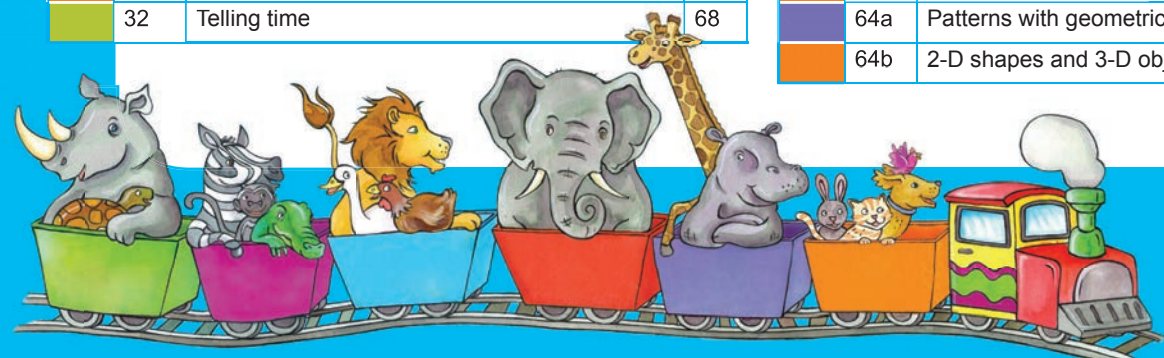

Published by the Department of Basic Education
222 Struben Street
Pretoria
South Africa

© Department of Basic Education
Ninth edition 2019

ISBN 978-1-920458-82-9

This book may not be sold.

The Department of Basic Education has made every effort to trace copyright holders but if any have been inadvertently overlooked the Department will be pleased to make the necessary arrangements at the first opportunity.

Grade 1



Mathematics

IN ENGLISH

ENGLISH

Book

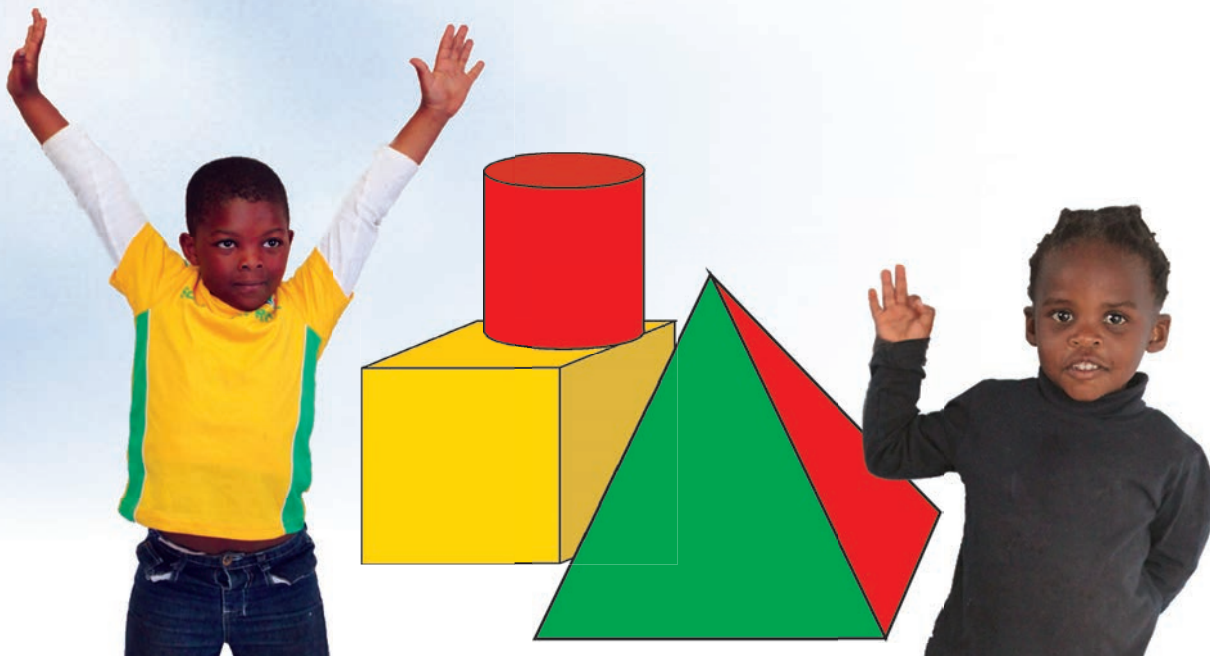

This book belongs to:

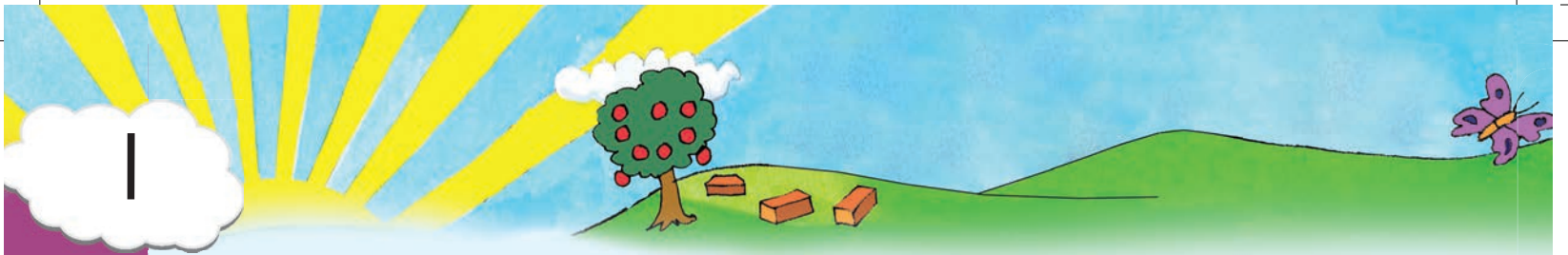

Revision: Tracking and matching



Help the girl to find all her toys.

START

FINISH





Matching

Find the picture that is the same as the one in the first box.

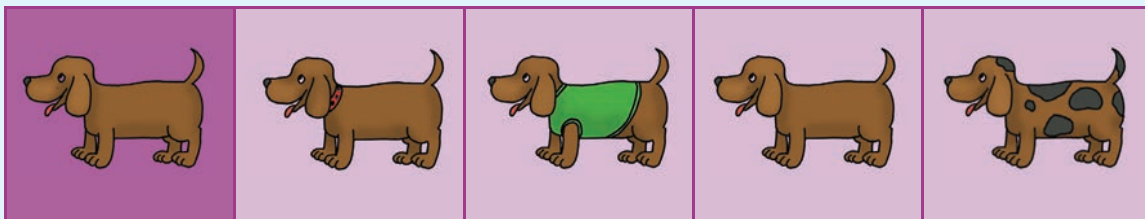
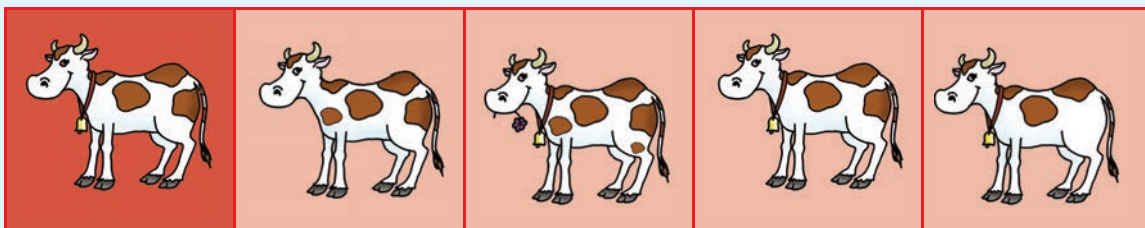
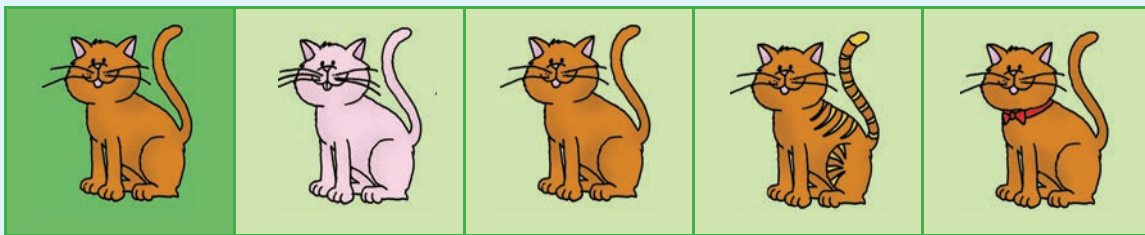
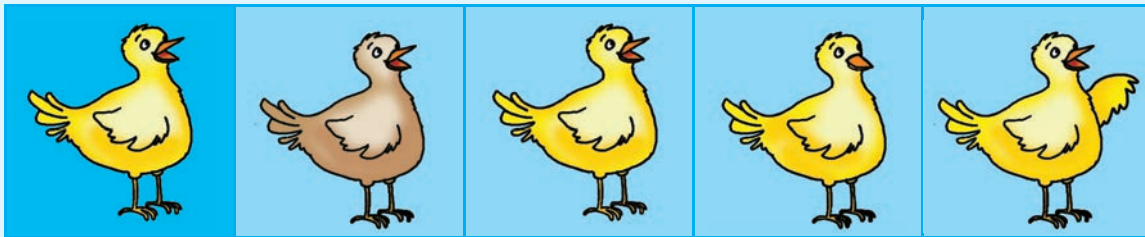

Teacher: _____
 Sign: _____
 Date: _____





Revision: Sorting colours and tracing patterns

Place the shapes, according to their colours, into the boxes.
 Each row must be the same colour as the first shape.
 We have done the red shapes as an example for you.
 Say what colour each shape is.
 Use cut-outs at the back of the book.

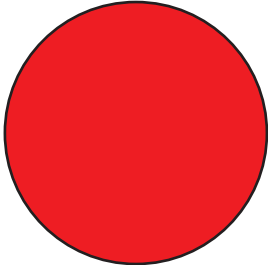
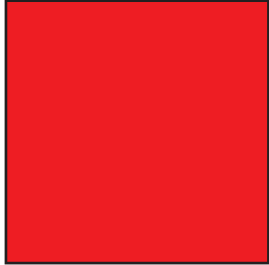
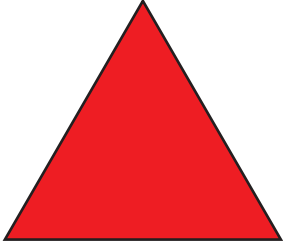
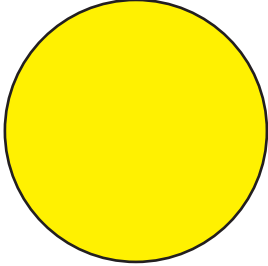
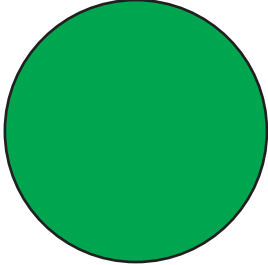
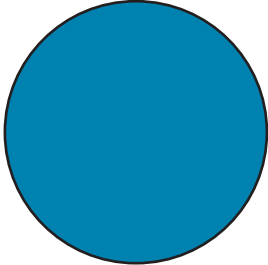



Patterns



Trace the dotted lines to complete the pattern on the whale.

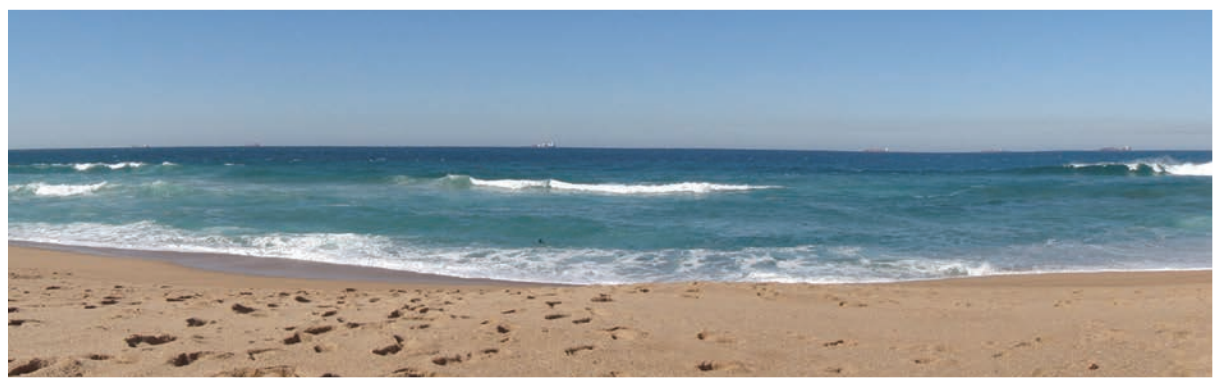
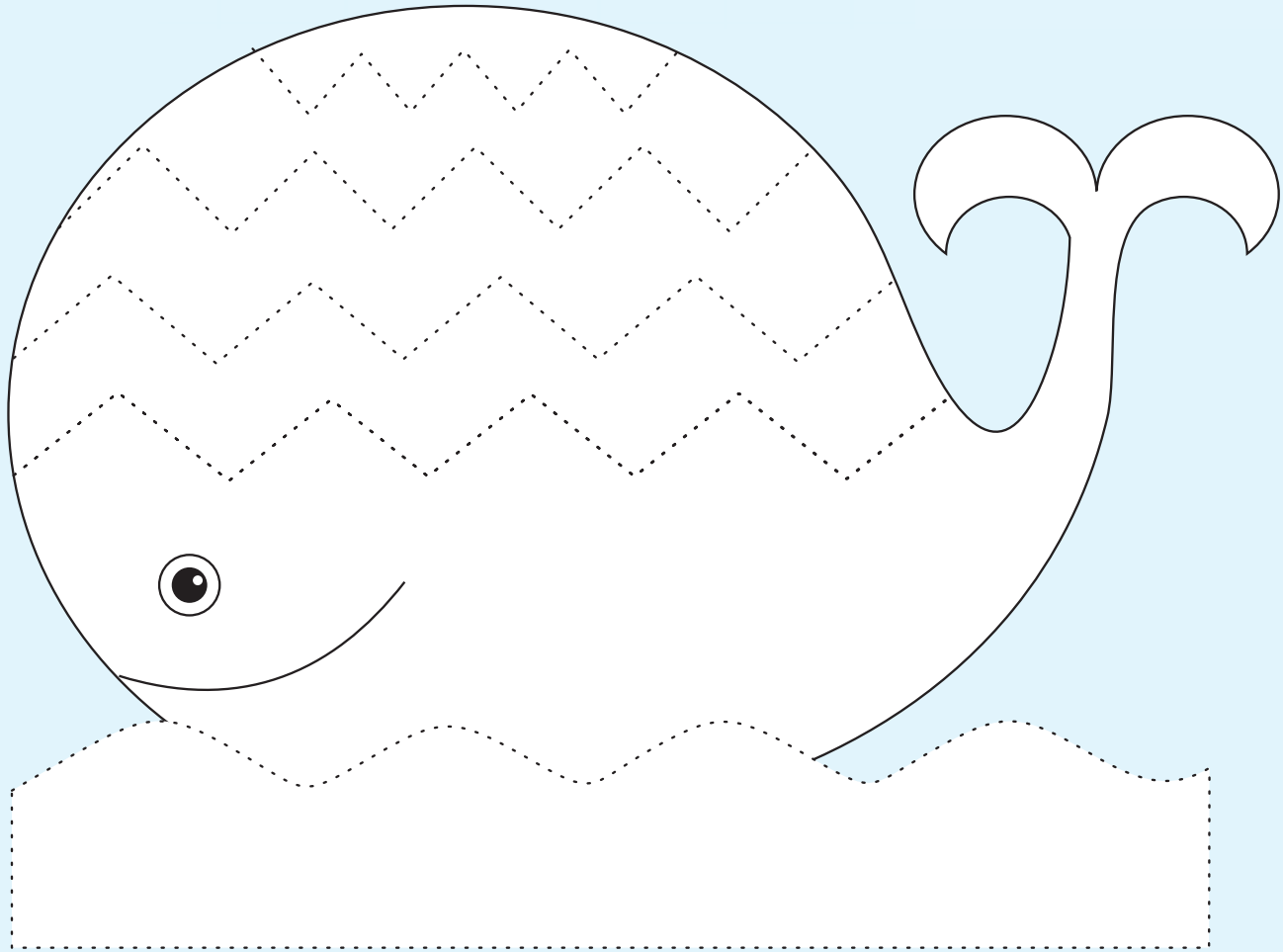

Teacher:
Sign:
Date:



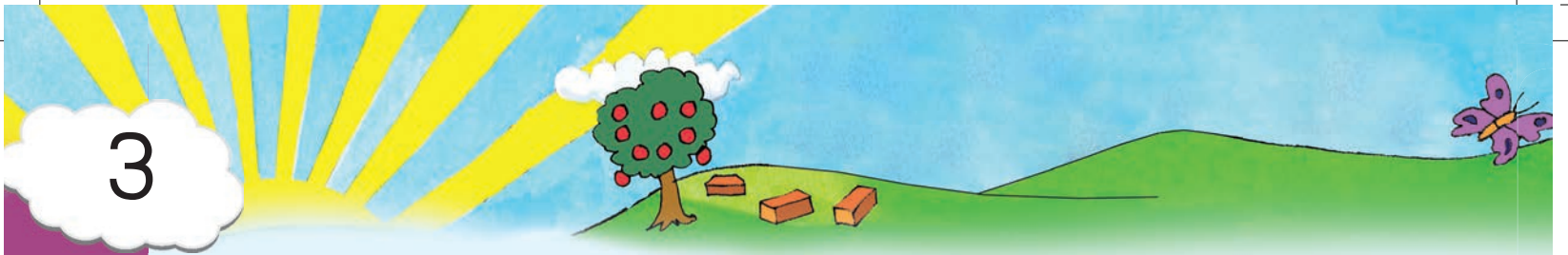

Revision: Colours and patterns

Draw a line to match the clothes that have the same colour.

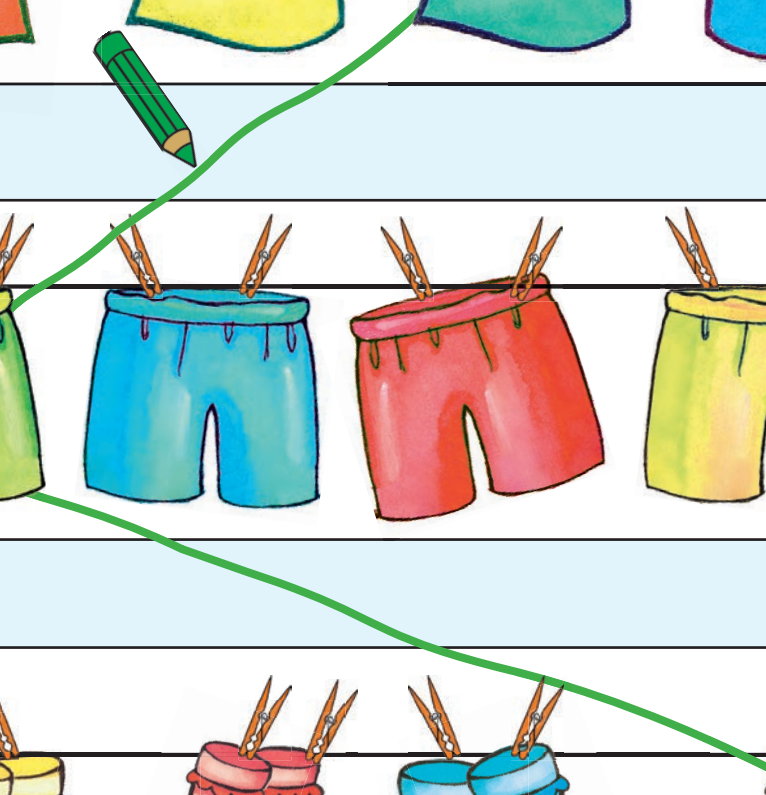
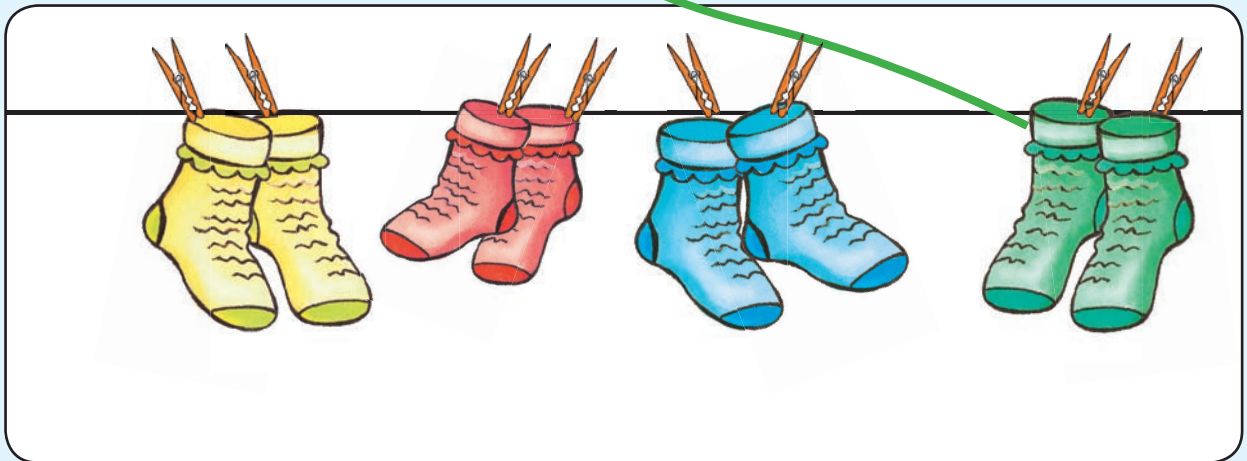
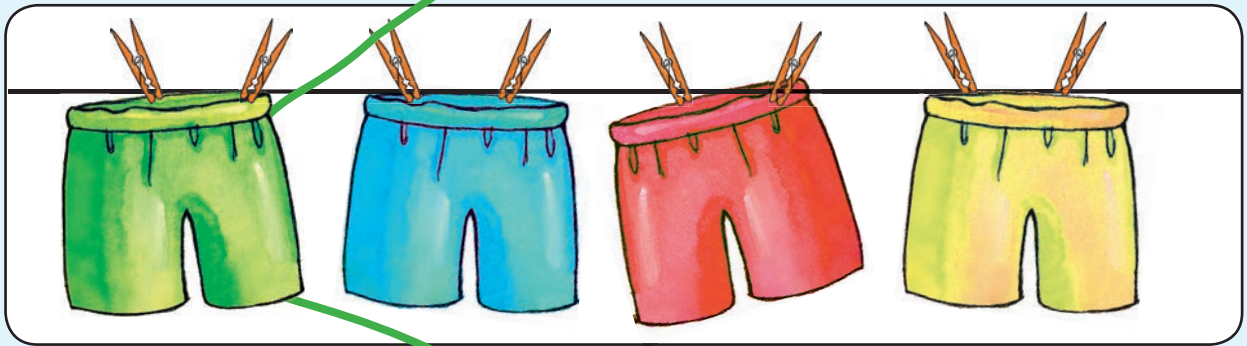
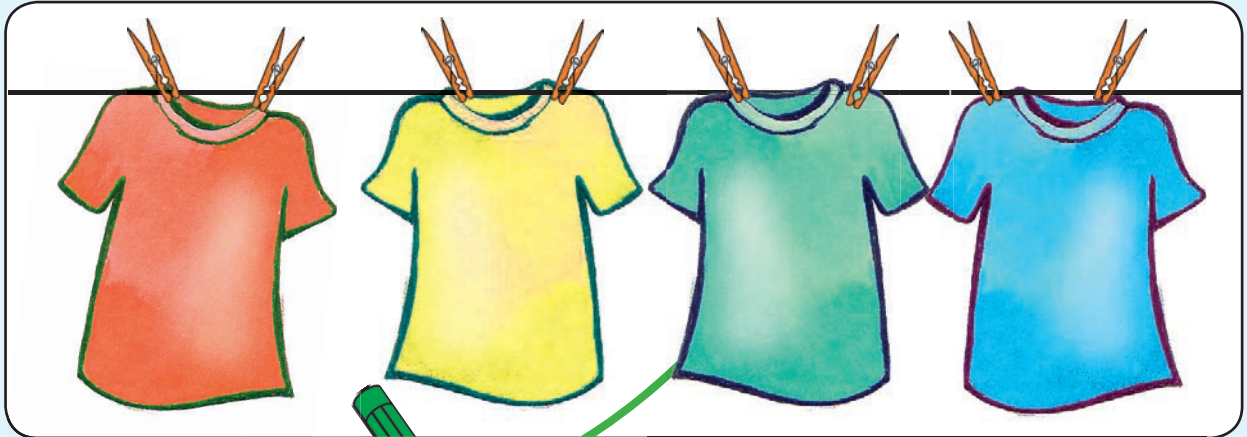



First trace the broken line patterns using your finger and then with your crayon or pencil. Then copy the smaller patterns started at the left. The first pattern will always guide you.



Teacher: _____
Sign: _____
Date: _____



Revision: Sorting and matching shapes



Use your cut-out circles from the back of the workbook and place them in these spaces.

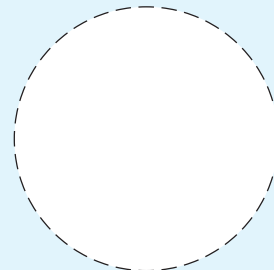
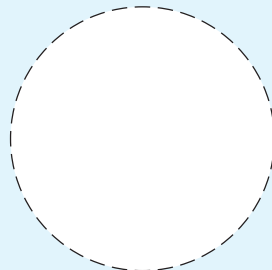
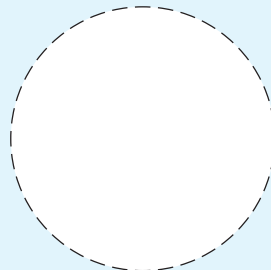
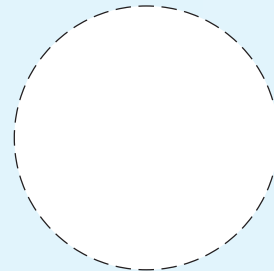
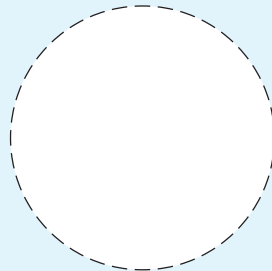
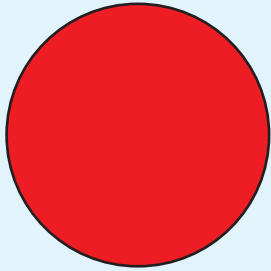

Use your cut-out squares and place them in these spaces.

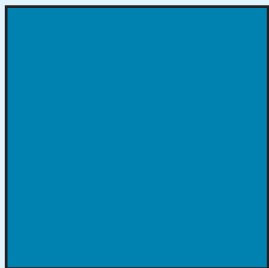



Find your cut-out triangles and put them in these spaces.

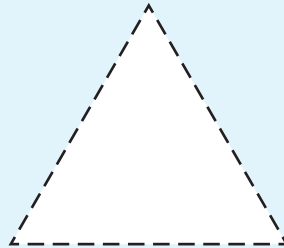
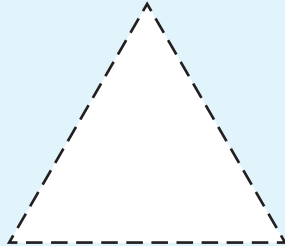
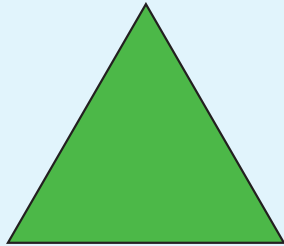

Use your cut-out rectangles and place them in these spaces.



Teacher:
Sign:
Date:



Revision: Find and count

Look at these pictures of animals.

Then count the number of each different kind of animal and draw the same number of dots in the correct block on the next page.

We have done the one for the cats for you.

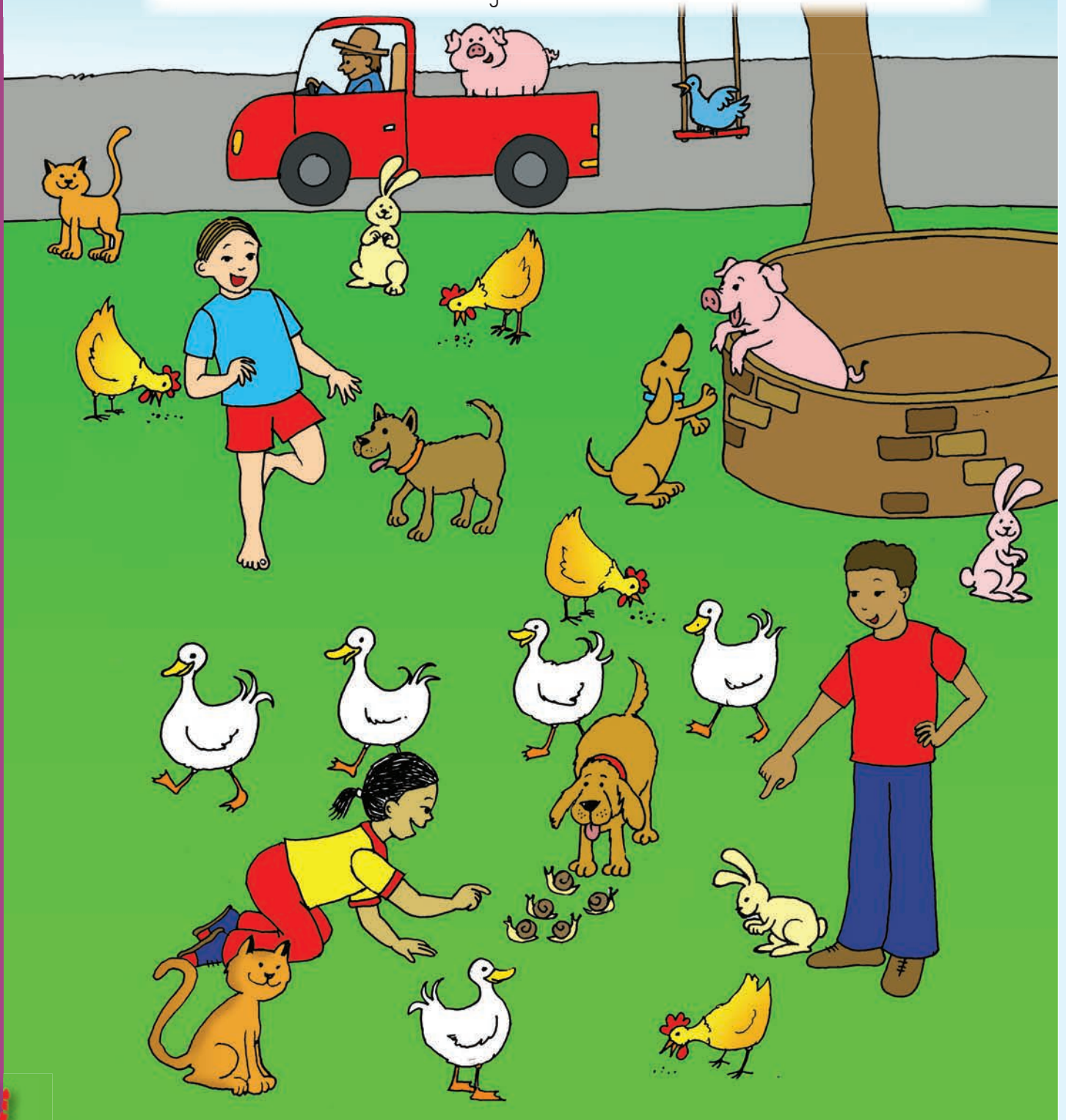

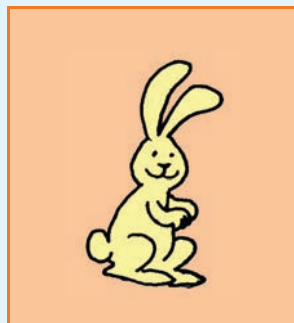
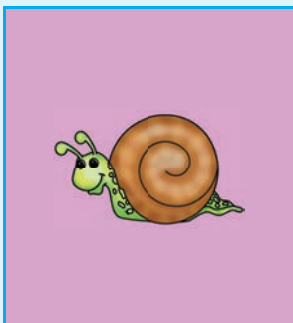
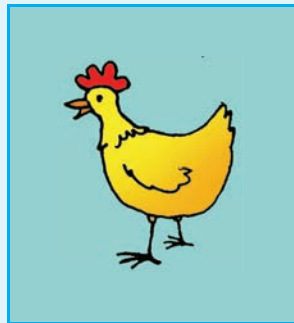
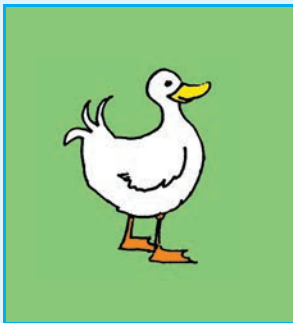
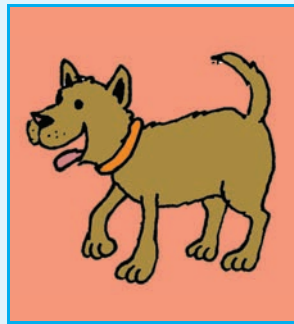
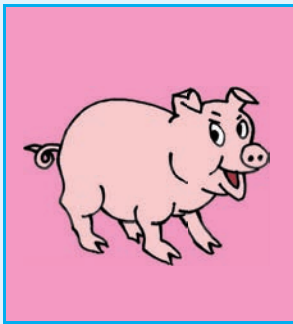
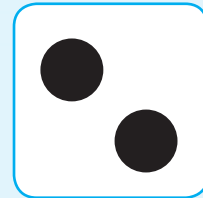
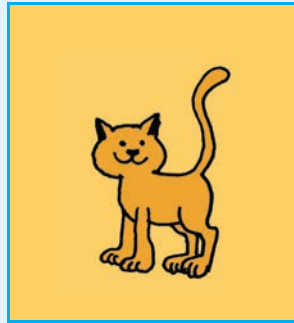
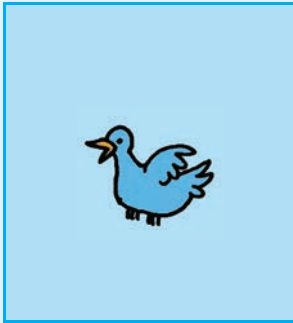

Teacher:
Sign:
Date:



Revision: Positions



Circle the animal in the row to show that it is in the same position as the green coloured block in the row. We have done the first one for you to see.



Circle the animal in this position in the row below.



Circle the animal in this position in the row below.

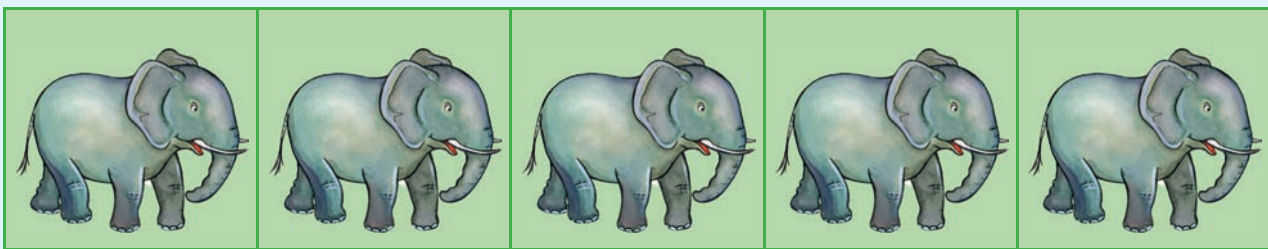

Circle the animal in this position in the row below.





First trace the patterns using your finger and then with your crayon or pencil.
The first pattern in the row will always guide you.

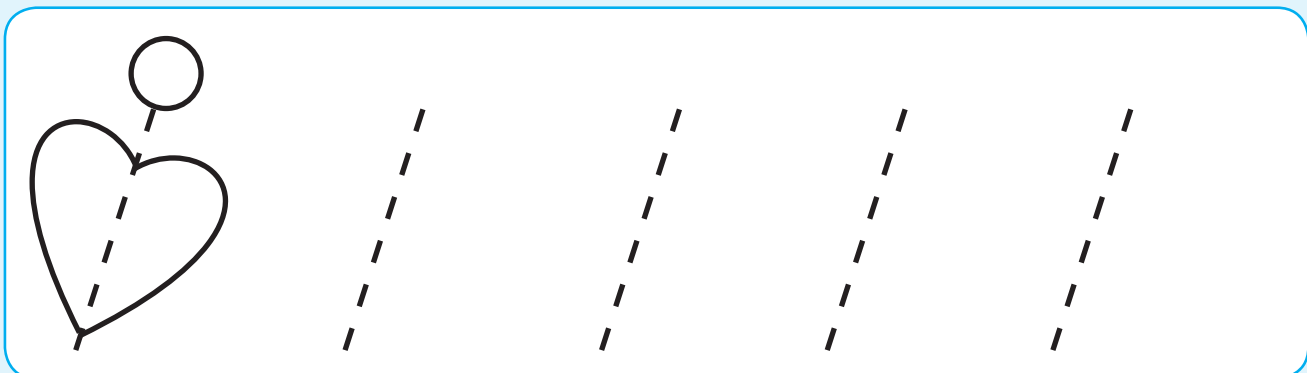
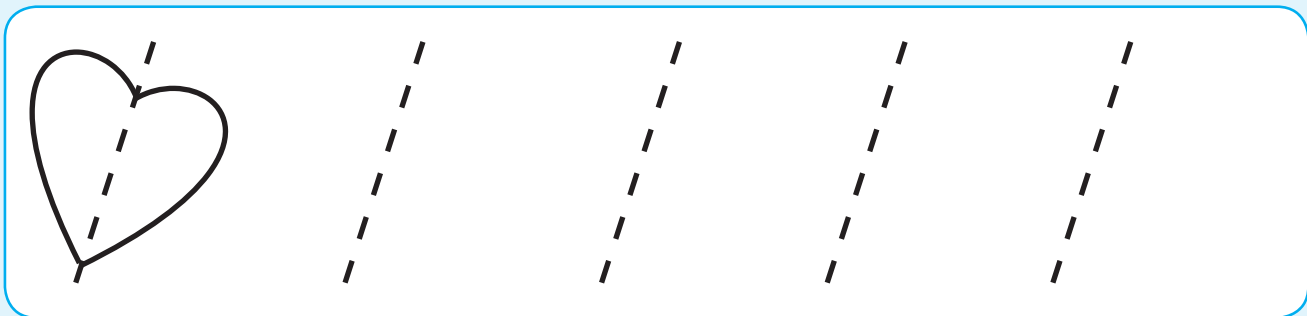
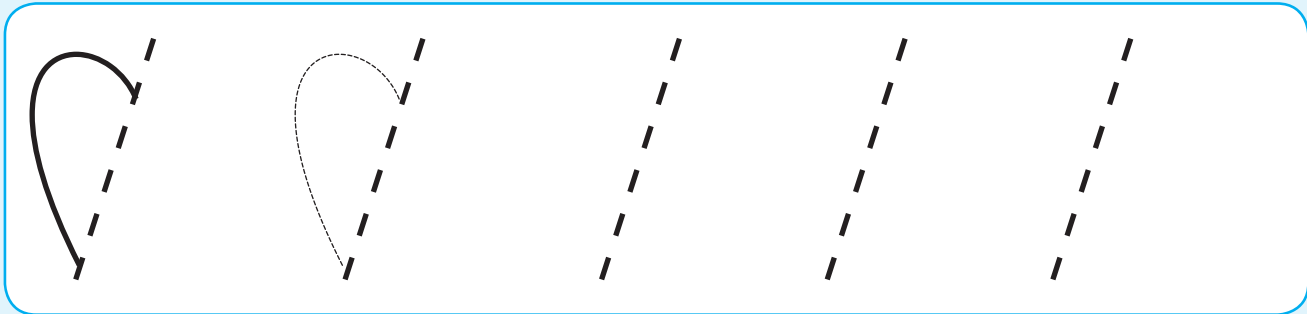
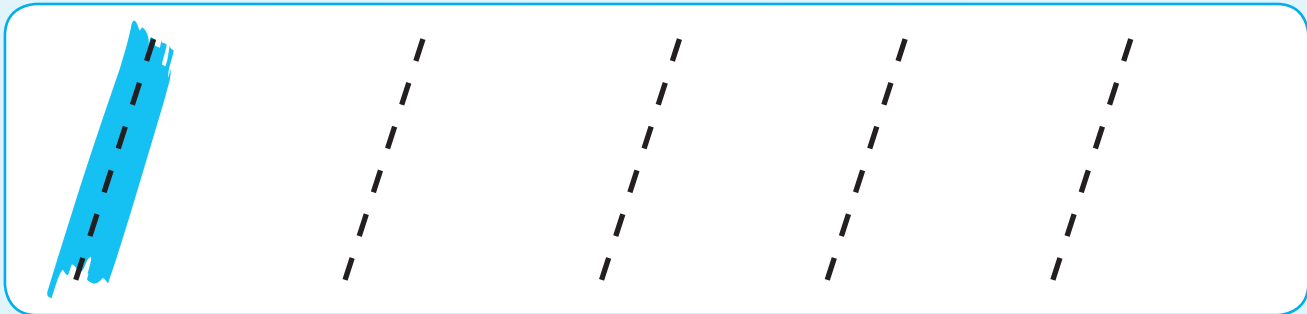

Teacher: _____
Sign: _____
Date: _____





Revision: Time

Look at the pictures and say what takes a longer time (✓) and what takes a shorter time (✗).
Tick (✓) what takes a longer time. Cross (✗) what takes a shorter time.



Walking to
school.



Driving to
school.



Making a
sandwich.



Making a cake.



Working at
school.



Playing a game
of soccer.



Painting a house.



Painting a
picture.



First trace the patterns using your finger and then with your crayon or pencil.
The first pattern in the row will always guide you.

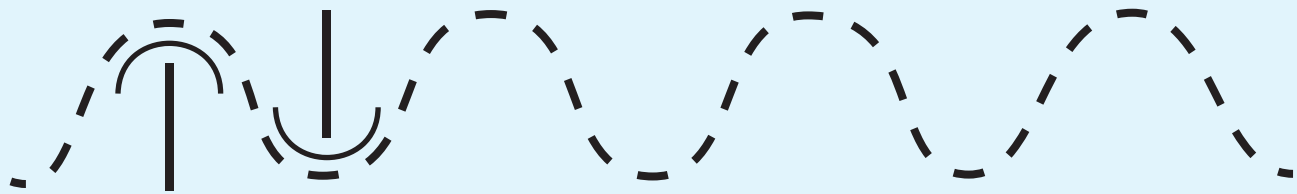
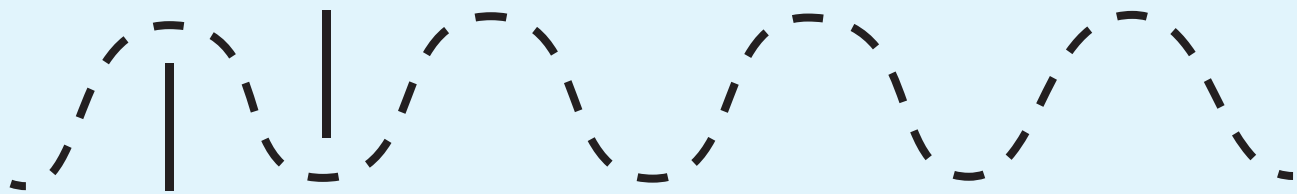
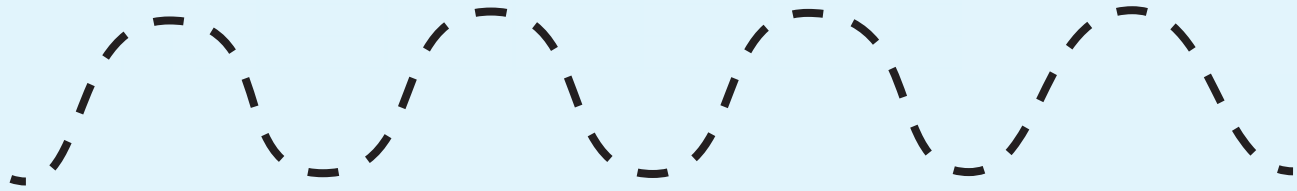

Teacher:
Sign:
Date:



Revision: Shapes, sizes and colours



Circle the object in each picture that is the biggest.

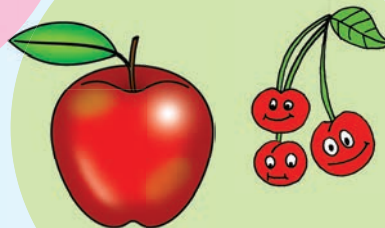
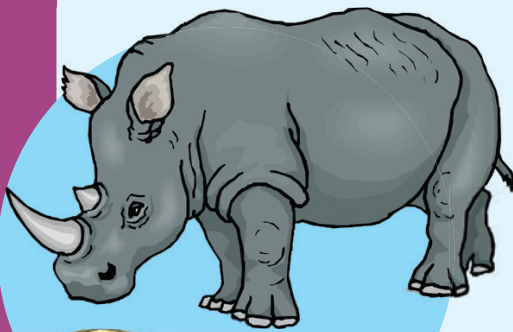
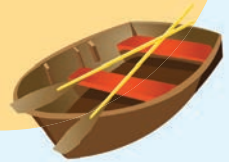



Colours

Circle those things that are the same colour as the paint in the first box.

--	--

--	--

--	--

--	--



Teacher: _____
 Sign: _____
 Date: _____



9

Term 1



One

Count the objects in the picture. Trace the number name.

one bee
one girl
one hut
one ball



Trace the number.



Match the pictures.





Colour in I shape or object in each block.

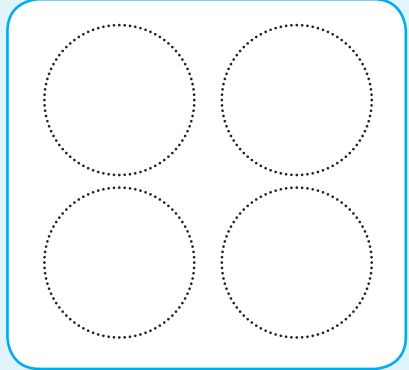
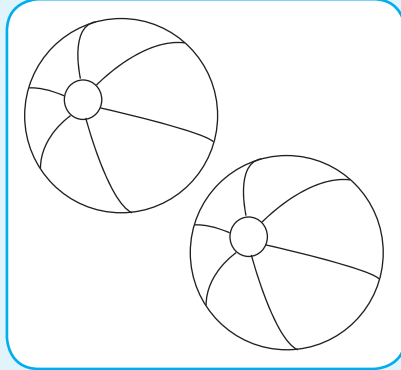
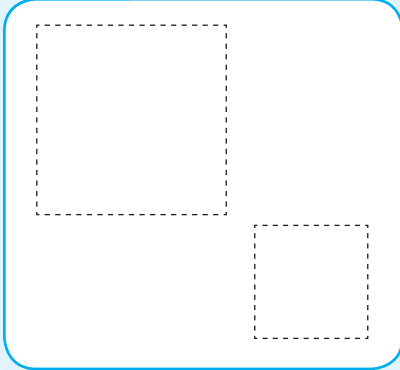

Copy and draw I more.

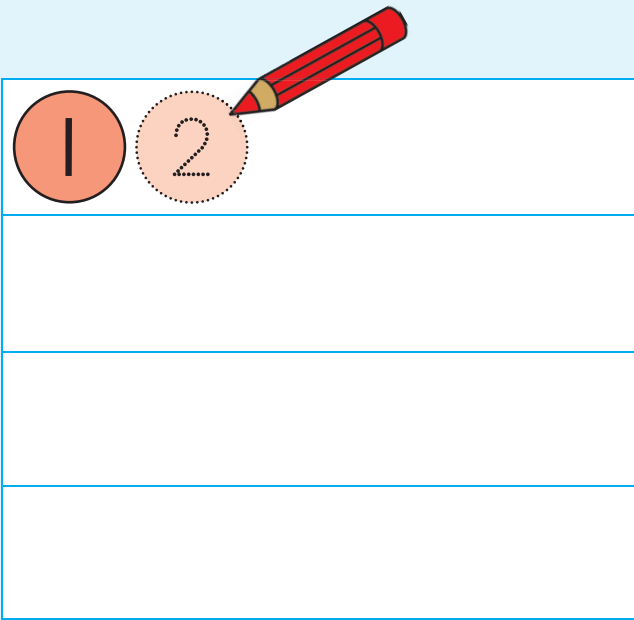
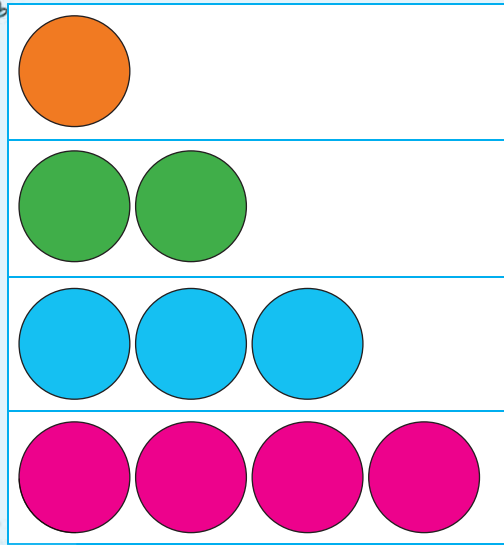

Practise the number.

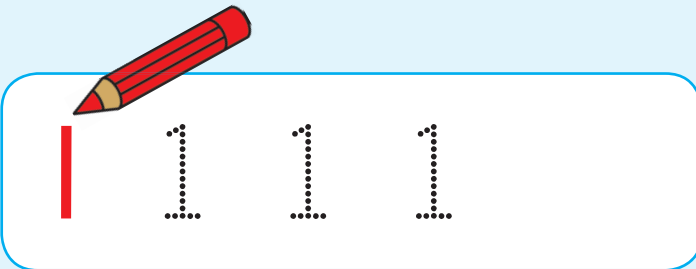

Colour the circles as you count.

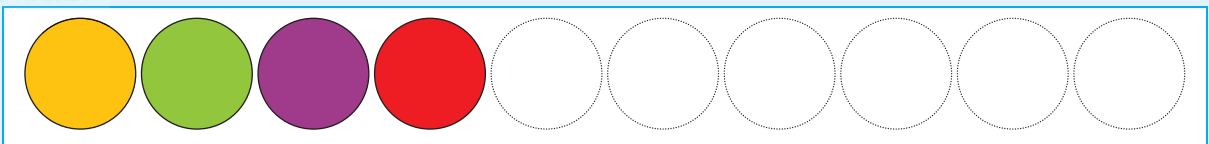

Teacher: _____
Sign: _____
Date: _____





Two



Count the objects in the picture. Trace the number name.

two trees
two boys
two kites
two dogs

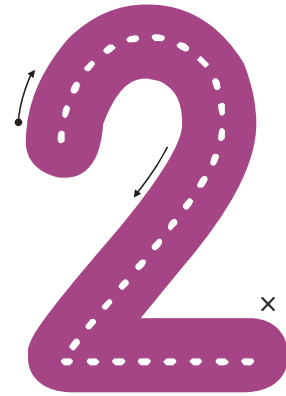

Trace the number.



Match the pictures.

Tracing practice for the number 2. It features a red pencil writing a solid number 2, followed by six rows of three dashed number 2s for tracing.

Matching exercise for the number 2. It consists of five boxes: the first contains two green squares; the second contains two cardboard boxes; the third contains two wrapped gifts; the fourth contains a dashed number 2; and the fifth contains two green squares.

Matching exercise for the number 2. It consists of five boxes: the first contains a dashed number 2; the second contains two wrapped gifts; the third contains two cardboard boxes; and the fourth contains two green squares.





Colour in 2 shapes or objects in each block.

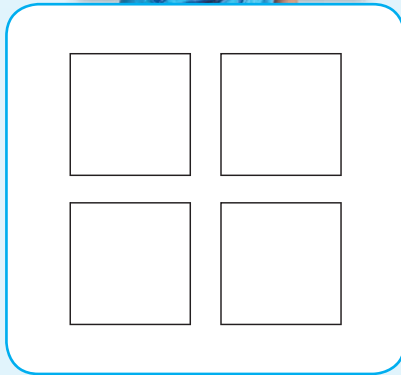
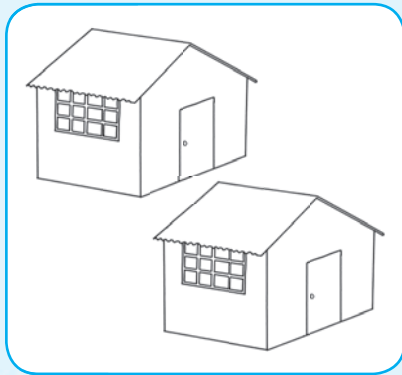

Copy and draw 2 more.

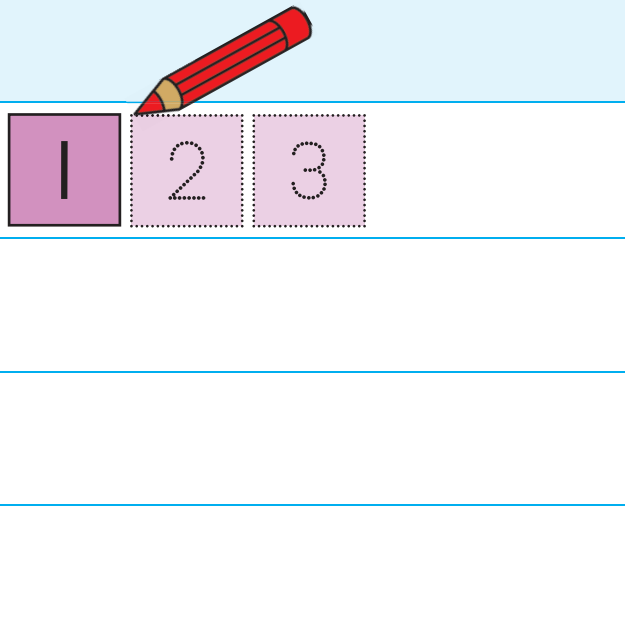
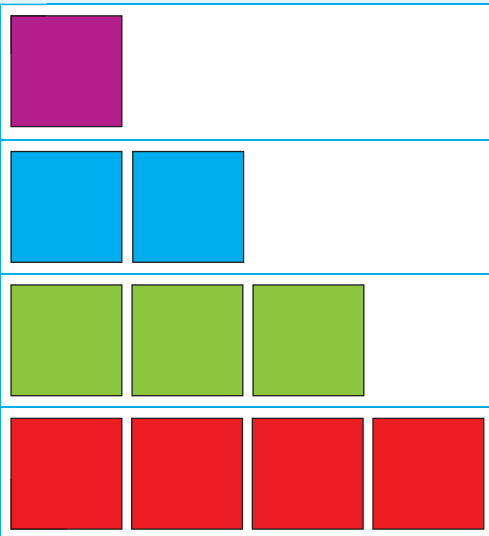

Practise the number.

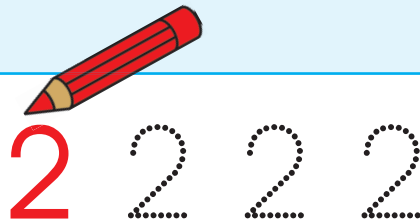

Colour the squares as you count.

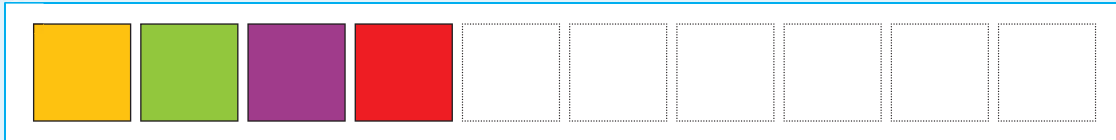

Teacher:
Sign:
Date:



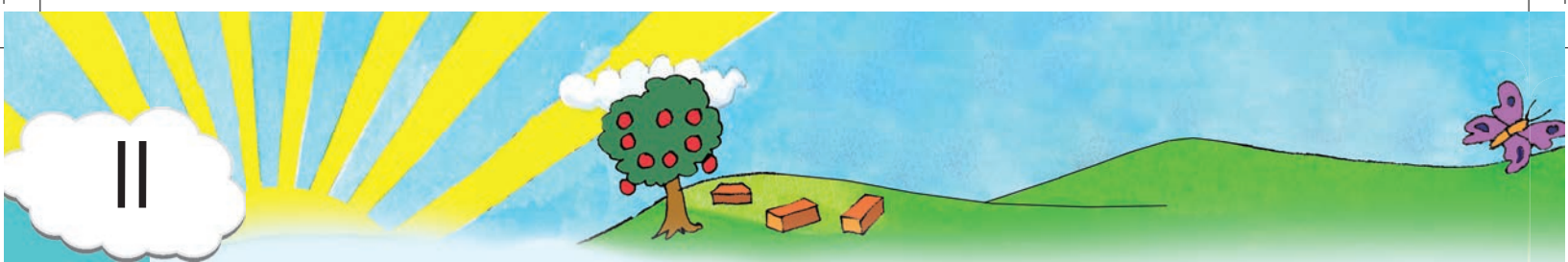

Three



Count the objects in the picture. Trace the number name.

three ducks
 three snails
 three flowers
 three worms

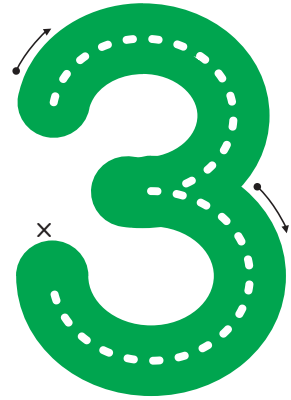
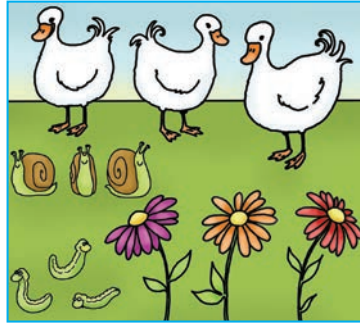

Trace the number.



Match the pictures.

Tracing practice for the number 3. It features a red pencil pointing to a solid red number 3, followed by two columns of seven dotted number 3s for tracing.

Matching exercise 1. A box containing three triangles (orange, yellow, pink) and three candies (purple, pink, orange) is shown above a box containing three ice cream cones and a dotted number 3.

Matching exercise 2. A box containing three triangles (orange, yellow, pink) and three candies (purple, pink, orange) is shown above a box containing three ice cream cones and a dotted number 3.





Colour in 3.

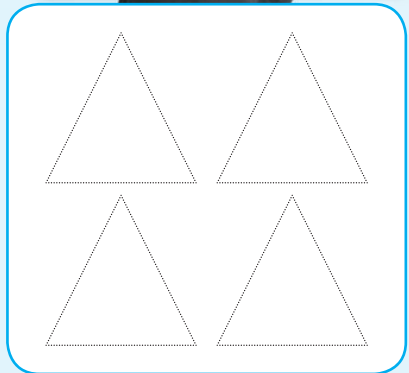
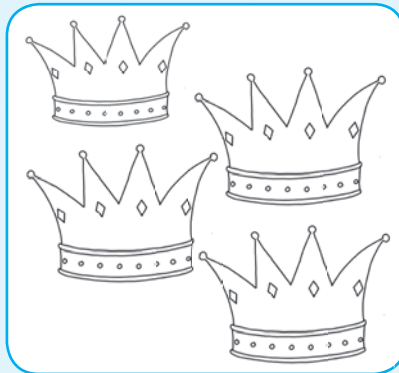

Copy and draw 3 more.

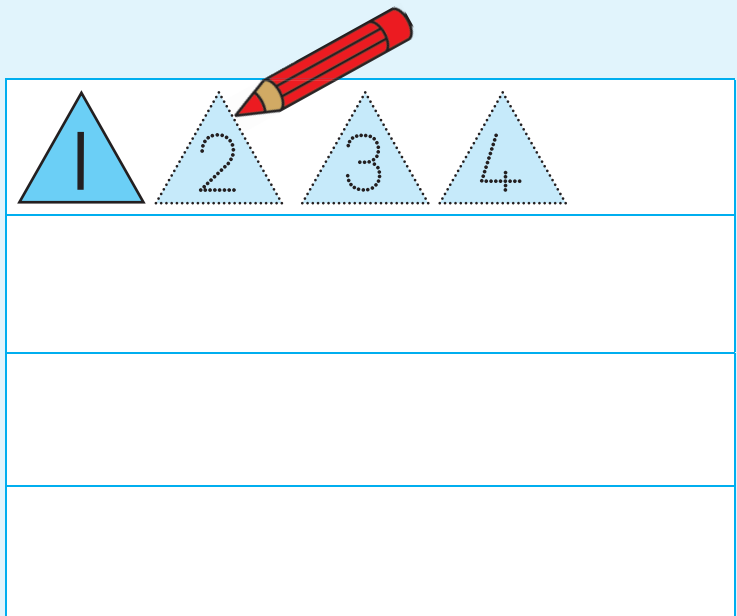
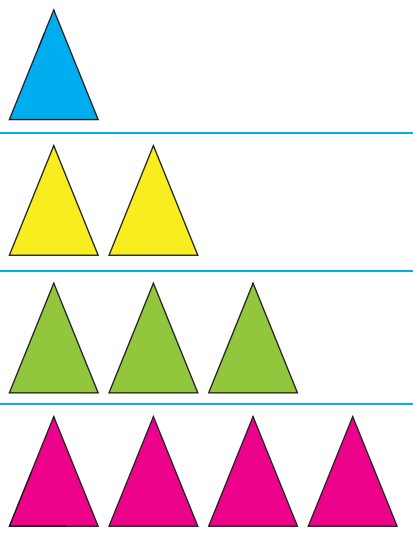

Practise the number.



three



Colour the triangles as you count.

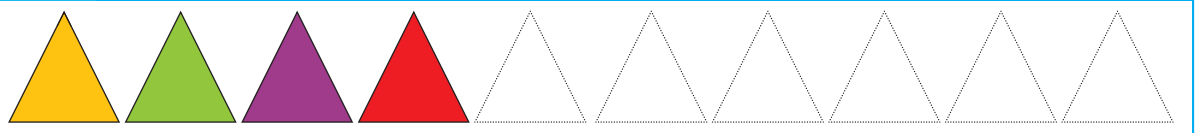

Teacher:
Sign:
Date:







I2a

Term 1



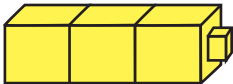
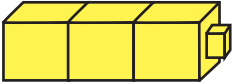

Length and position



Tick (✓) the shortest train.

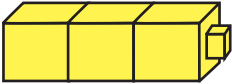

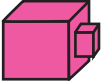
 <input type="checkbox"/>	 <input type="checkbox"/>	 <input type="checkbox"/>
 <input type="checkbox"/>	 <input type="checkbox"/>	 <input type="checkbox"/>

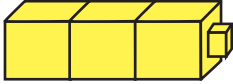
Tick (✓) the longest train.

 <input type="checkbox"/>	 <input type="checkbox"/>	 <input type="checkbox"/>
 <input type="checkbox"/>	 <input type="checkbox"/>	 <input type="checkbox"/>

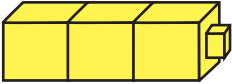

Draw a train that is longer.



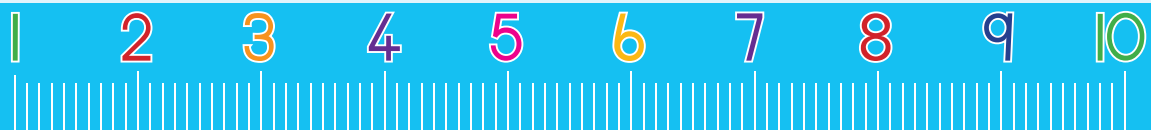

Colour the correct word. The short train is:

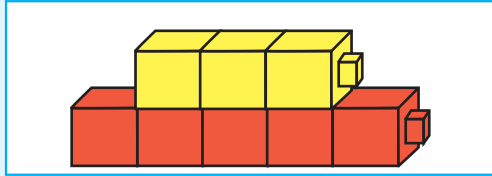

in front on top behind

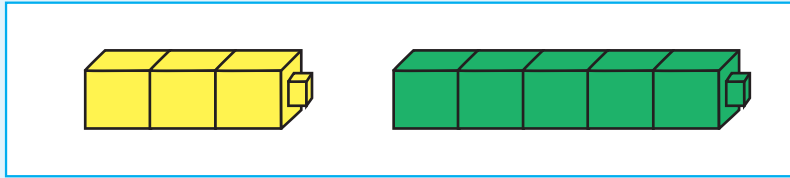

in front on top behind

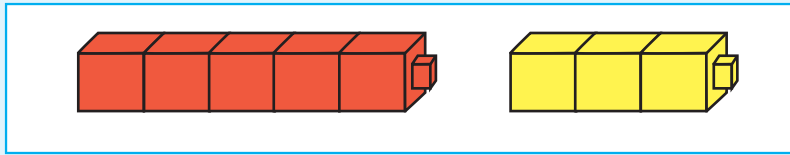

in front on top behind



Draw a longer train.

on top

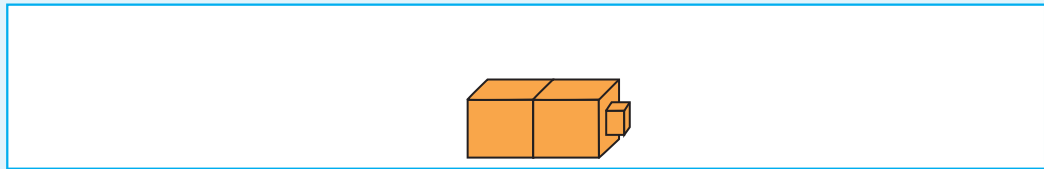

next to

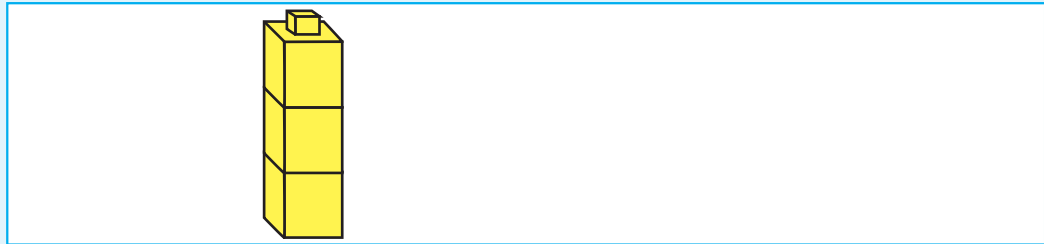

in front

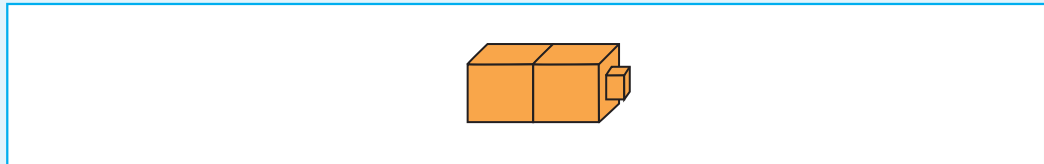

Teacher:
Sign:
Date:



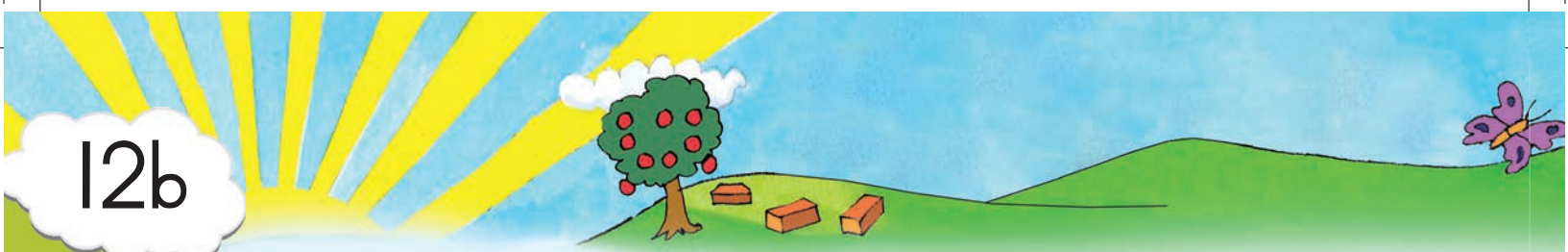

Length



Circle the shorter object in each picture.

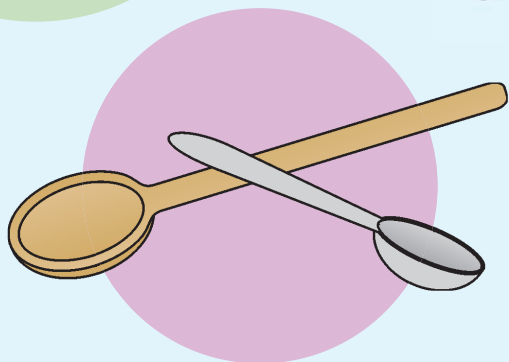
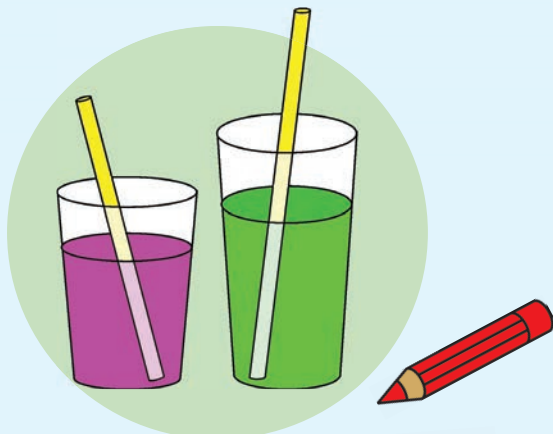
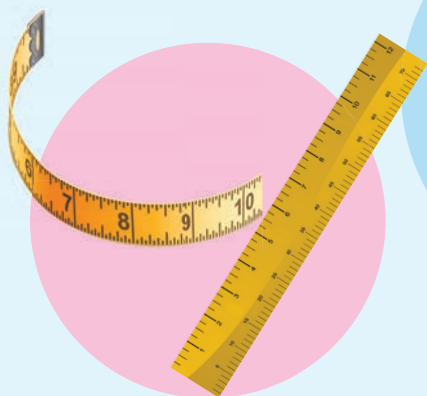

short	long
-------	------



Tick the correct answer.

Tick the tallest.

 <input type="checkbox"/> <input type="checkbox"/>	 <input type="checkbox"/> <input type="checkbox"/>	 <input type="checkbox"/> <input type="checkbox"/>
---	---	---

Tick the shortest pencil.

 <input type="checkbox"/> <input type="checkbox"/>	 <input type="checkbox"/> <input type="checkbox"/>	 <input type="checkbox"/> <input type="checkbox"/>
---	---	---

Tick the wider crayon.

 <input type="checkbox"/> <input type="checkbox"/>	 <input type="checkbox"/> <input type="checkbox"/>	 <input type="checkbox"/> <input type="checkbox"/>
---	---	---



Draw one building that is shorter and one that is taller than the one below.

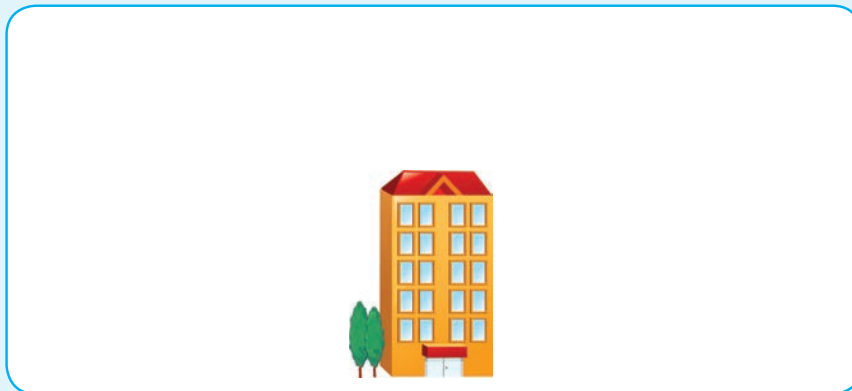

Draw one river that is wider and one that is narrower than the one in the picture.















Teacher: _____
 Sign: _____
 Date: _____

















Compare numbers 1 to 3

Tick the blocks that have the same number of objects.

 <input type="checkbox"/>	 <input type="checkbox"/>	 <input type="checkbox"/>	 <input type="checkbox"/>
 <input type="checkbox"/>	 <input type="checkbox"/>	 <input type="checkbox"/>	 <input type="checkbox"/>
 <input type="checkbox"/>	 <input type="checkbox"/>	 <input type="checkbox"/>	 <input type="checkbox"/>



Tick the block or blocks that have more objects than the shaded block.

 <input type="checkbox"/>	 <input type="checkbox"/>	 <input type="checkbox"/>	 <input type="checkbox"/>
 <input type="checkbox"/>	 <input type="checkbox"/>	 <input type="checkbox"/>	 <input type="checkbox"/>
 <input type="checkbox"/>	 <input type="checkbox"/>	 <input type="checkbox"/>	 <input type="checkbox"/>





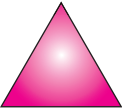
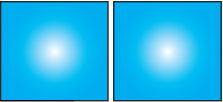

Copy and draw one more shape on the right-hand side.



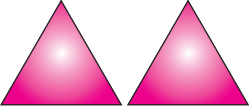

Draw one less shape on the right-hand side.



Draw one less shape on the right-hand side.

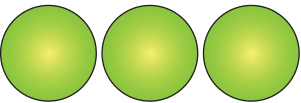

Trace the smallest of the three numbers.

		
---	---	---



Teacher:
Sign:
Date:





Four



Count the objects in the picture. Trace the number name.

four cats
four ants
four leaves
four bugs

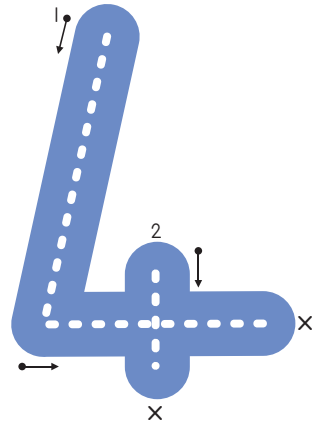
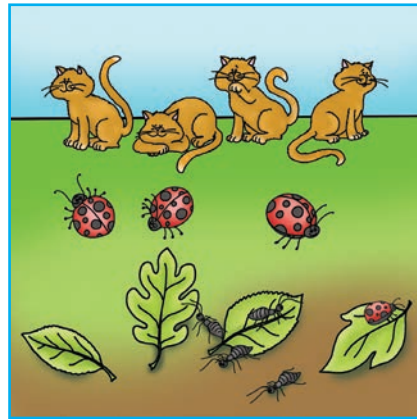

Trace the number.



Match the pictures.

Tracing practice for the number 4. It features a red pencil drawing a solid number 4, followed by six rows of three dashed number 4s for tracing.

Matching exercise for the number 4. It consists of five boxes: a dashed number 4, a diamond shape divided into four quadrants, four leaves, and four pyramids (two yellow and pink, two blue and green).

Matching exercise for the number 4. It consists of five boxes: four leaves, a dashed number 4, a diamond shape divided into four quadrants, and four pyramids (two yellow and pink, two blue and green).





Colour in 4 objects or shapes in each block.

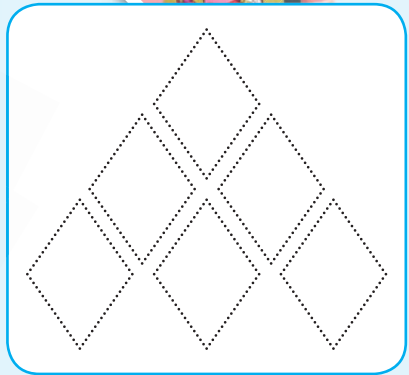
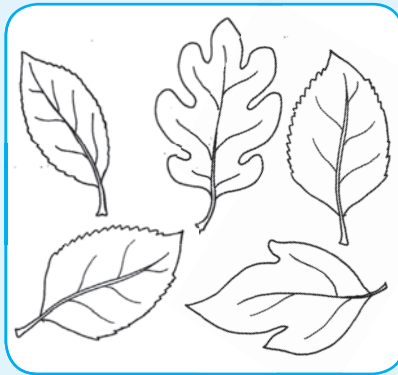
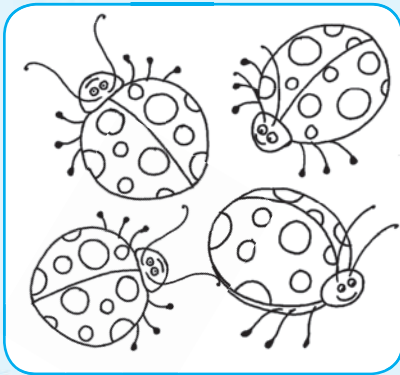

Copy and draw 4 more shapes and colour them.



Practise the number.



four

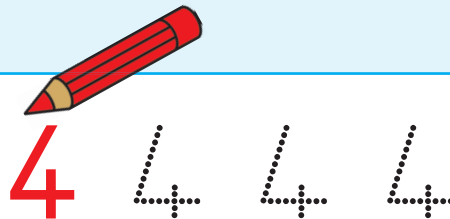

Colour the diamond shapes as you count.

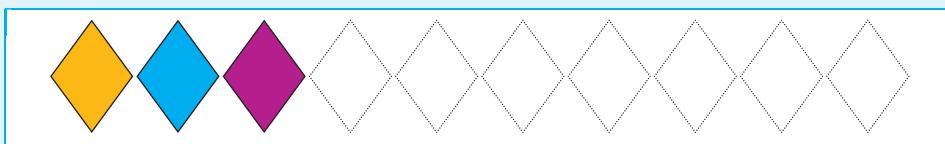







Teacher: _____
Sign: _____
Date: _____



Add and subtract up to 4

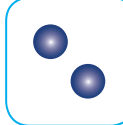
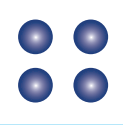

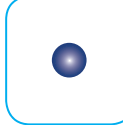
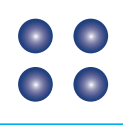

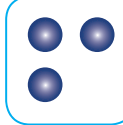
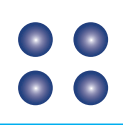



Complete the following by making a drawing:

	and		makes	<input type="text"/>		and	<input type="text"/>	makes	
	and		makes	<input type="text"/>		and	<input type="text"/>	makes	
	and		makes	<input type="text"/>		and	<input type="text"/>	makes	



How many counters are left?
Draw them.



Draw more counters to make 4.

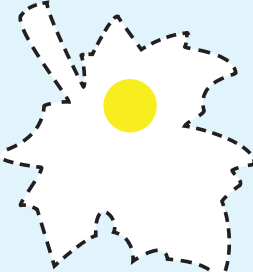
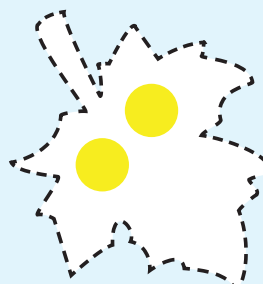
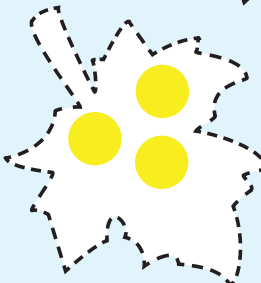

Write a number sentence for:

	4	take away	<input type="text"/>	makes	3
	<input type="text"/>	take away	<input type="text"/>	makes	<input type="text"/>
	<input type="text"/>	take away	<input type="text"/>	makes	<input type="text"/>

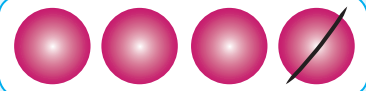
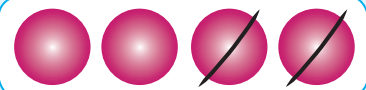
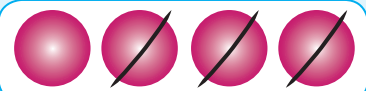

Add these and then fill in the answer.



1 and 2 makes

3

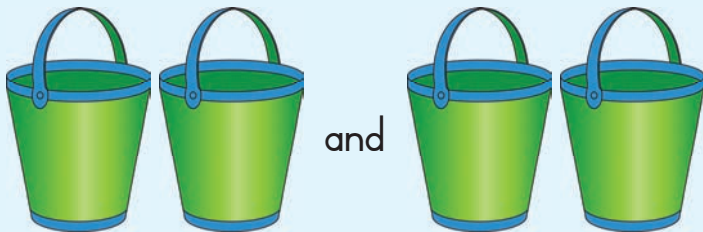

2 and 2 makes



3 and 1 makes



1 and 3 makes

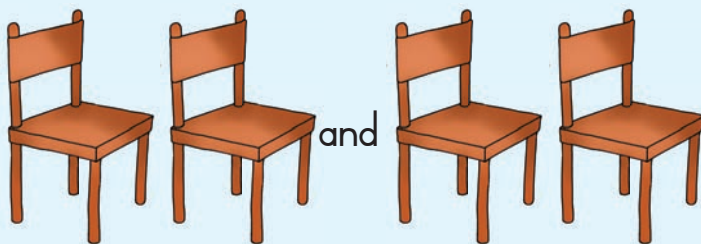

2 and 2 makes



Teacher:
Sign:

Date:



Time



Write the numbers 1 to 4 in the blocks to show the order in which a person grows.

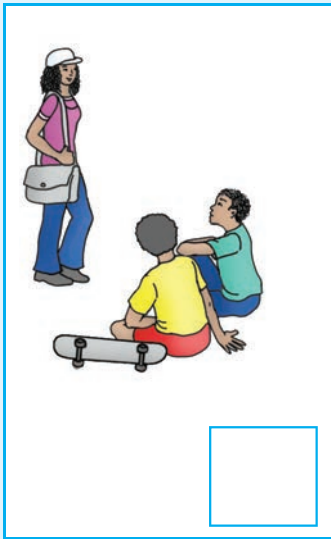



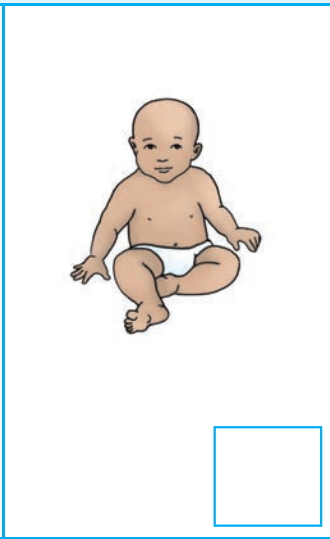

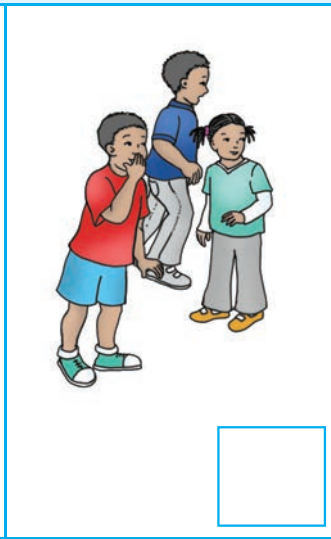



Tick to say which one you would do fastest.

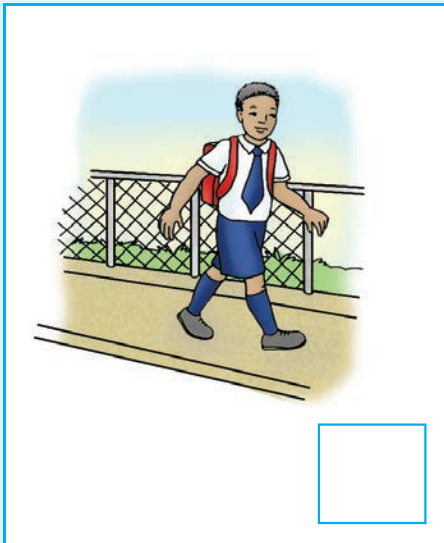

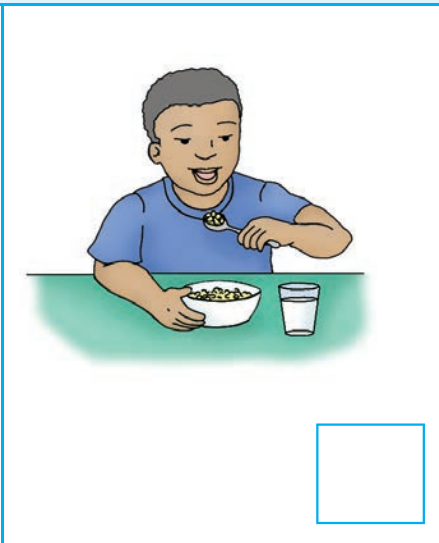





1

2

3

4

1

2

3

4



Draw something:

a. you did yesterday

A large, empty rectangular box with rounded corners and a blue border, intended for drawing. In the bottom right corner of the box, there is a small illustration of a bunch of colorful pencils.

b. you did today

A large, empty rectangular box with rounded corners and a blue border, intended for drawing. In the bottom right corner of the box, there is a small illustration of a bunch of colorful pencils.

c. you will do tomorrow

A large, empty rectangular box with rounded corners and a blue border, intended for drawing. In the bottom right corner of the box, there is a small illustration of a bunch of colorful pencils.

Teacher:
Sign:
Date:





Five



Count the objects in the picture. Trace the number name.

five teddies
 five sweets
 five stars
 five stripes



Trace the number.



Match the pictures.

Tracing practice for the number 5. It features a red pencil pointing to a solid red number 5, followed by three columns of five dotted number 5s for tracing.

Matching exercise 1. A box containing five purple oval shapes. Below it, a box containing five brown egg shapes. Below that, a box containing five colorful Easter eggs. At the bottom, a box containing a dotted number 5.

Matching exercise 2. A box containing five colorful Easter eggs. Below it, a box containing a dotted number 5. Below that, a box containing five brown egg shapes. At the bottom, a box containing five purple oval shapes.



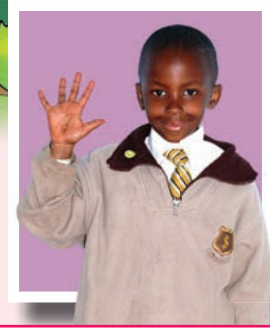
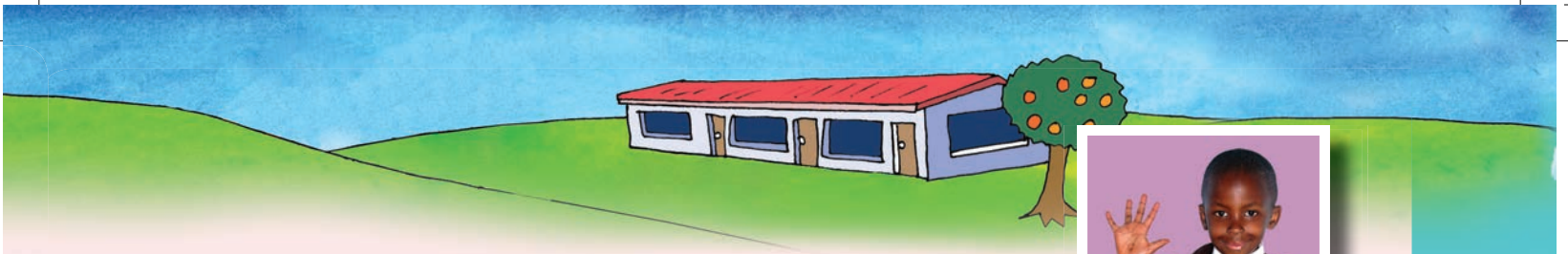

Colour in 5 in each block.

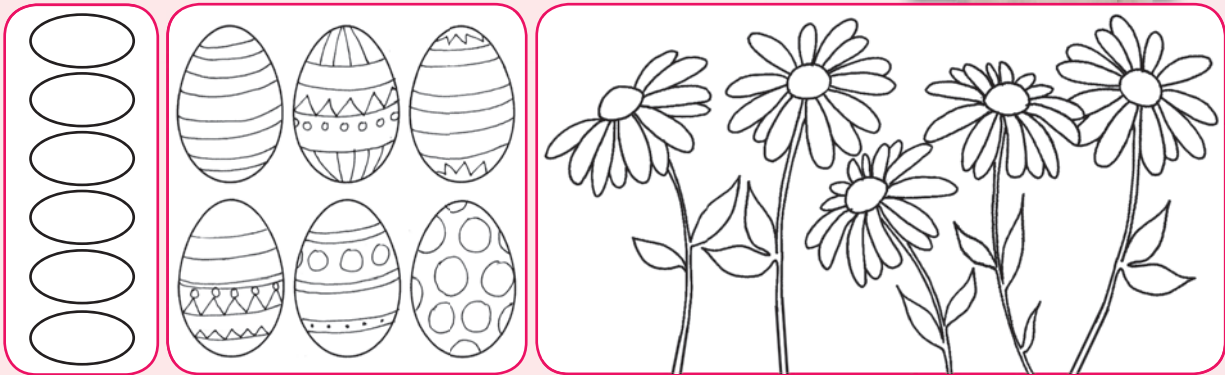

Copy and draw 5 more.

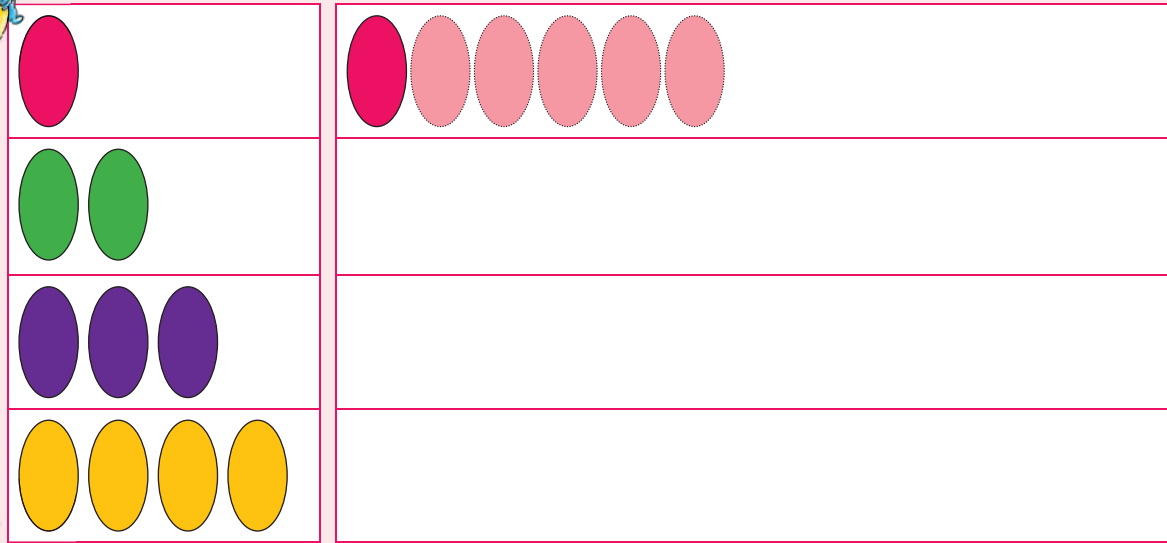

Practise the number.

5

five

5 5 5 5



Colour the ovals as you count.

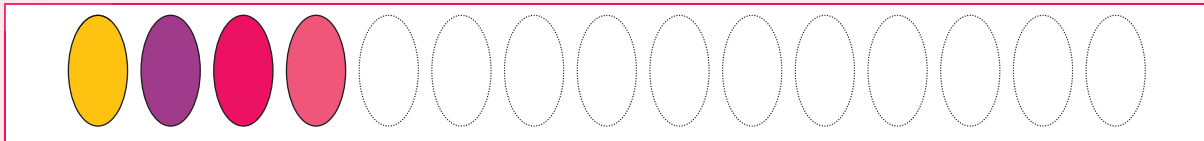

Teacher:
Sign:
Date:



Revise numbers 1 to 5

Practise writing number symbols 1 to 5.

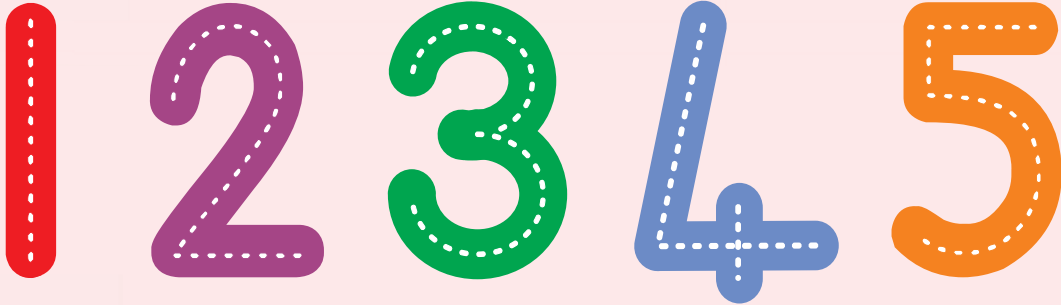

Count the objects and circle the correct number symbol.

	1	2	3	4	5	6	7
	1	2	3	4	5	6	7
	1	2	3	4	5	6	7
	1	2	3	4	5	6	7
	1	2	3	4	5	6	7



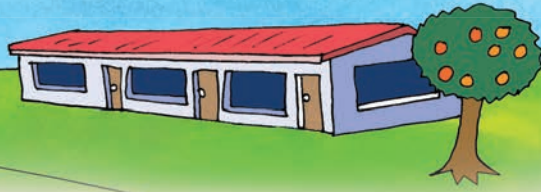

Trace the word for each of the numbers.

	1	one
	2	two
	3	three
	4	four
	5	five



Teacher:
Sign:
Date:



Add up to 5

Add to the beads by drawing more.

Draw one more.

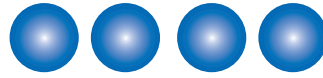

Draw two more.



Draw three more.

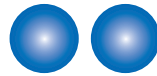

Count and add these and then fill in the answer.



and



2 and 2 makes 4

2

2



and



2 and 1 makes



and



3 and 2 makes



and



2 and 3 makes



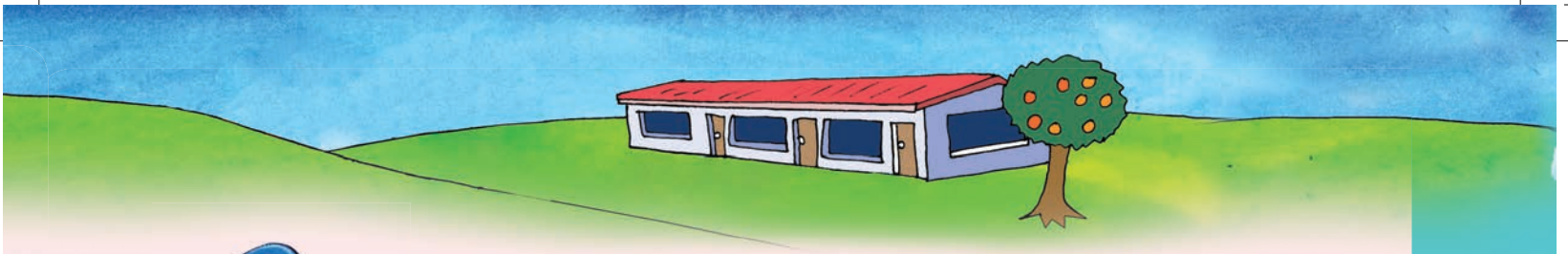

Draw more triangles. What do you notice?

	1 more	
	2 more	
	3 more	
	4 more	



Draw the answer and then write a sum for:

	and		give	
3	and	2	give	5
	and		give	
	and		give	
	and		give	
	and		give	



Teacher:
Sign:
Date:





Subtract from 5 and add up to 5

Draw less.

	1 less	
	2 less	
	3 less	
	4 less	



Write a sum for:

	5	take away	1	is	4
		take away		is	
		take away		is	



Subtract by counting back.

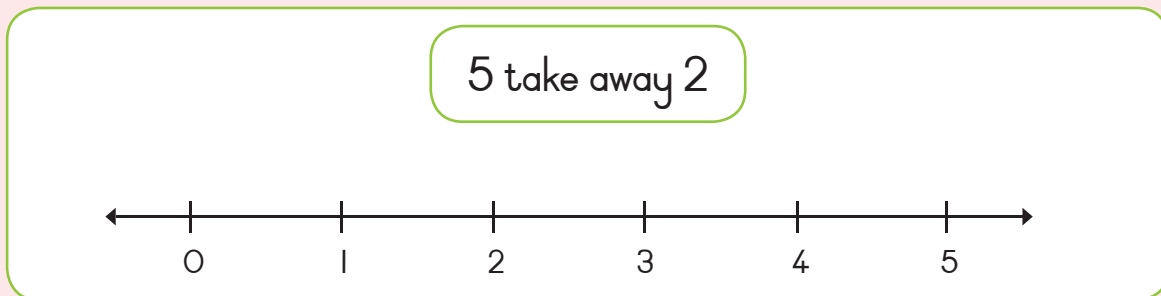
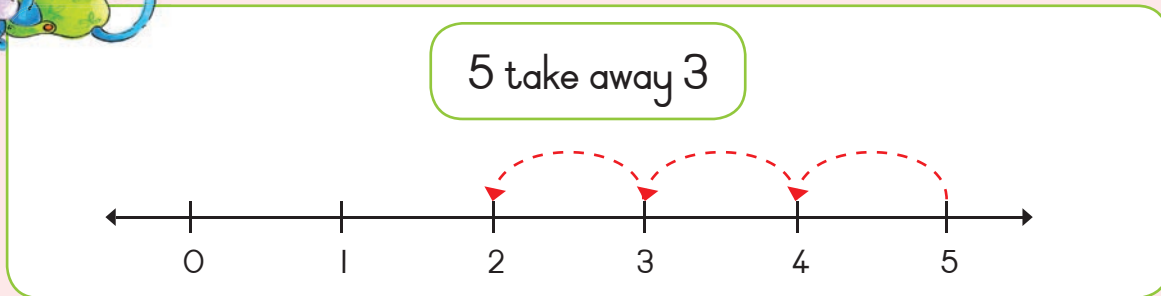

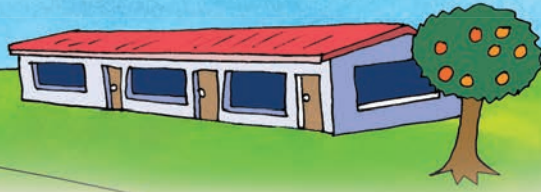

Add by counting on.

2 add 3

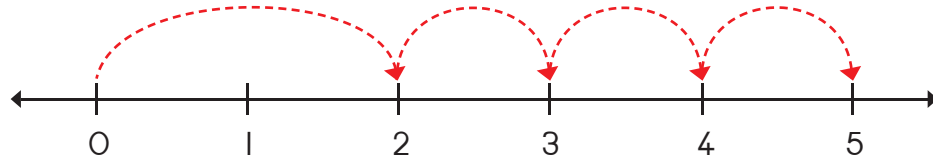

1 add 4



Show the sum on the number line.

5 take away 2

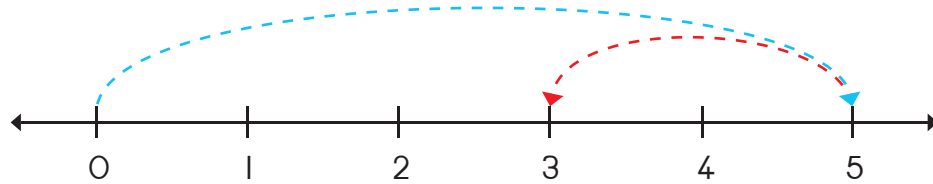

5 take away 4



Teacher:
Sign:

Date:



Add and subtract up to 5



Complete the following:



and



give me

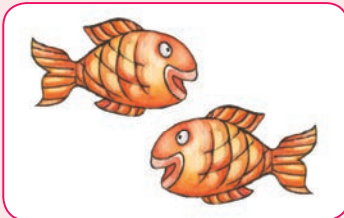

and

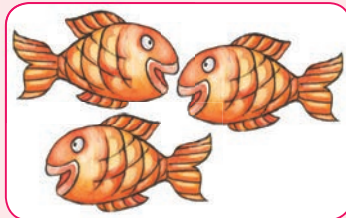

give me

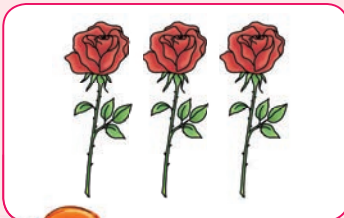

and



give me



Complete the following:

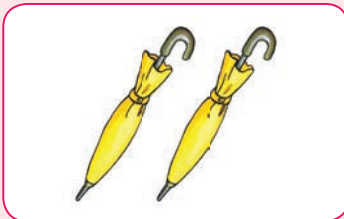

and

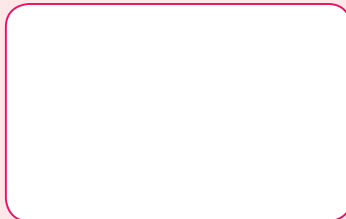

give me

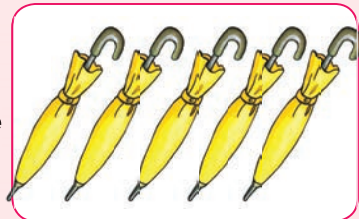

and



give me



and

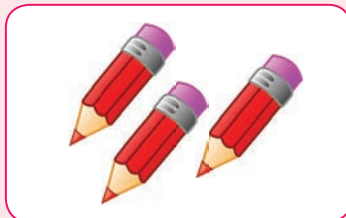

give me

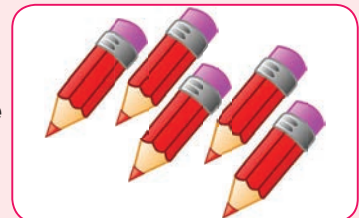



Draw more apples to make 5.

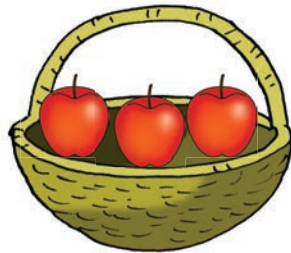
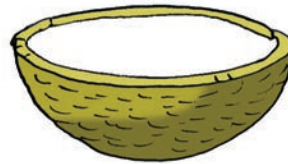
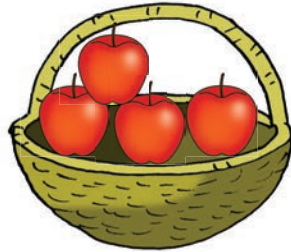
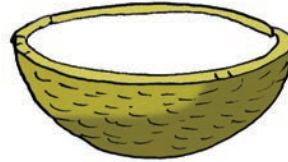
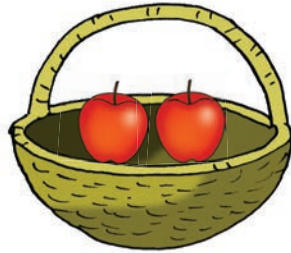

How many beads are left? Draw them.

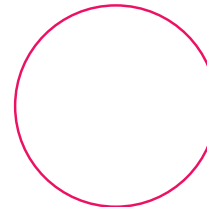
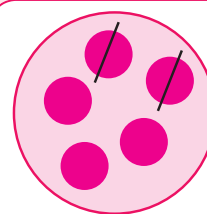
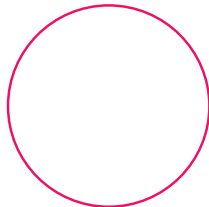
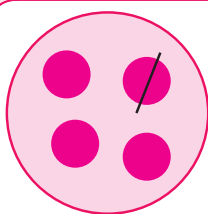

Word problems.

Your teacher/parent will read this to you and you need to make a drawing to solve it.

Lisa had two pears. Musa gave her one pear. How many pears does she have now?

Lisa had four pears. Musa gave two pears to Lisa. How many pears does she have now?



Teacher:

Sign:

Date:





Addition and subtraction 1 to 5

Colour the beads to show:

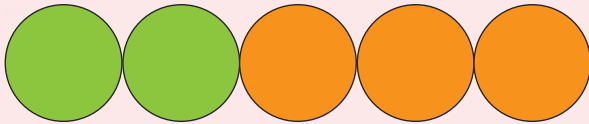

2 and 3 is 5

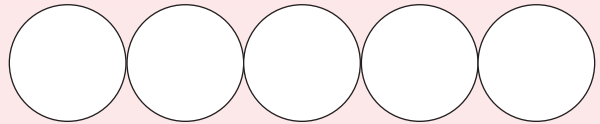

1 and 4 is 5

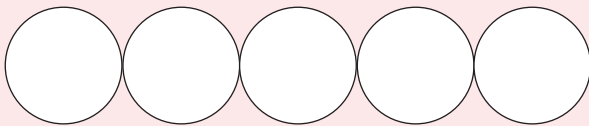

3 and 2 is 5

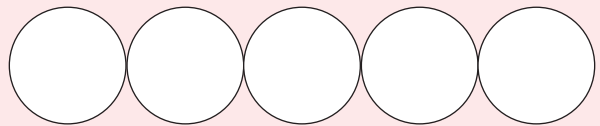

4 and 1 is 5



Cross out the beads to show:

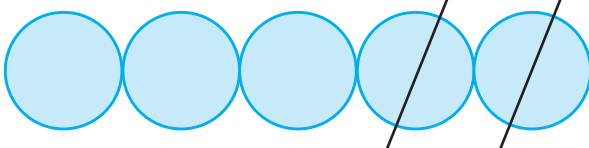

5 take away 2 is 3

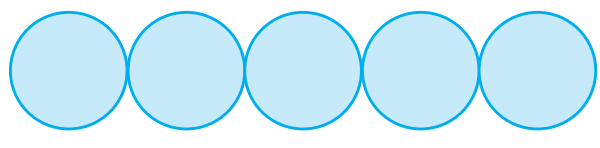

5 take away 1 is 4

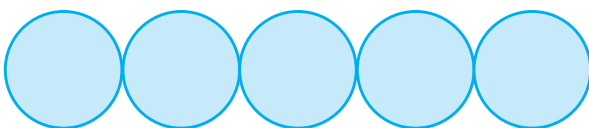

5 take away 3 is 2

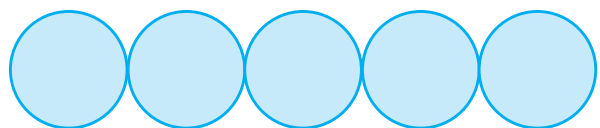

5 take away 4 is 1



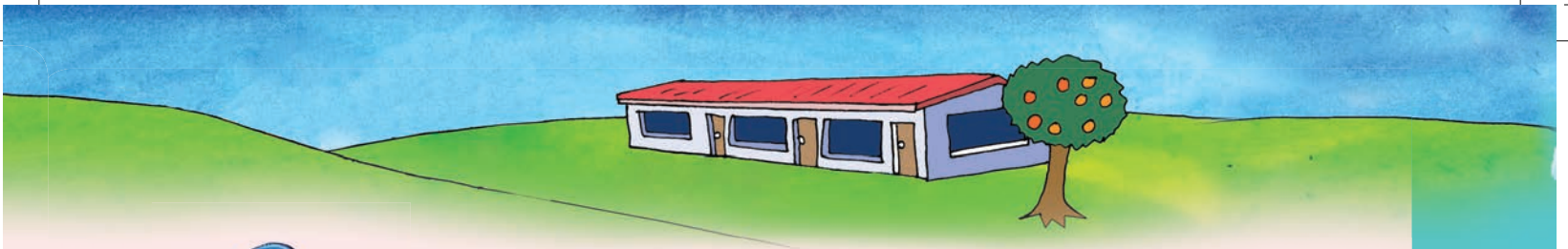

Colour the beads. Help the frog to show it on the number line.

2 and 3 is

0 1 2 3 4 5

3 and 2 is

0 1 2 3 4 5

1 and 4 is

0 1 2 3 4 5

4 and 1 is

0 1 2 3 4 5



Cross out the beads you take away and show it on the number line.

5 take away 3

0 1 2 3 4 5

5 take away 2

0 1 2 3 4 5

5 take away 1

0 1 2 3 4 5

5 take away 4

0 1 2 3 4 5



Teacher:
Sign:

Date:





Balls and boxes



Which of these pictures look like boxes?
Mark the square.
Which of these pictures look like balls?
Mark the circle.

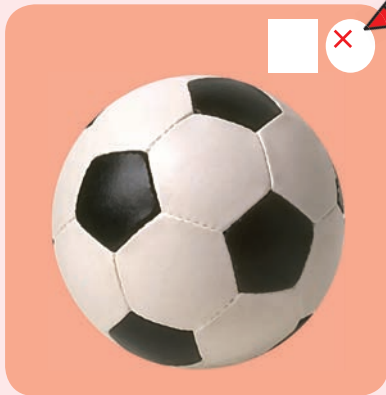
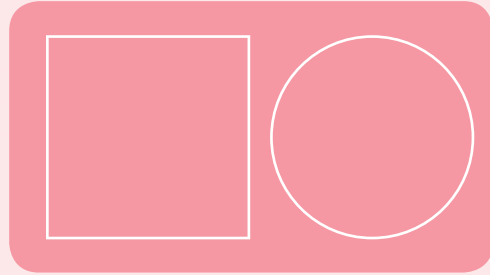

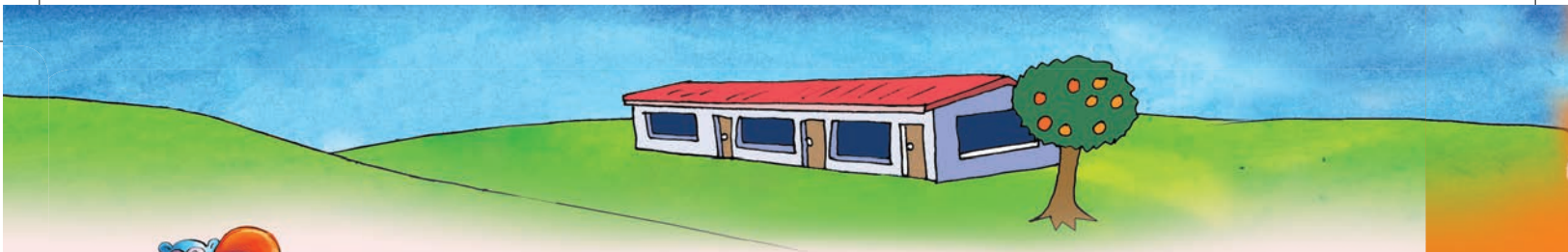

Colour all the:

- small boxes and balls red
- big boxes and balls blue

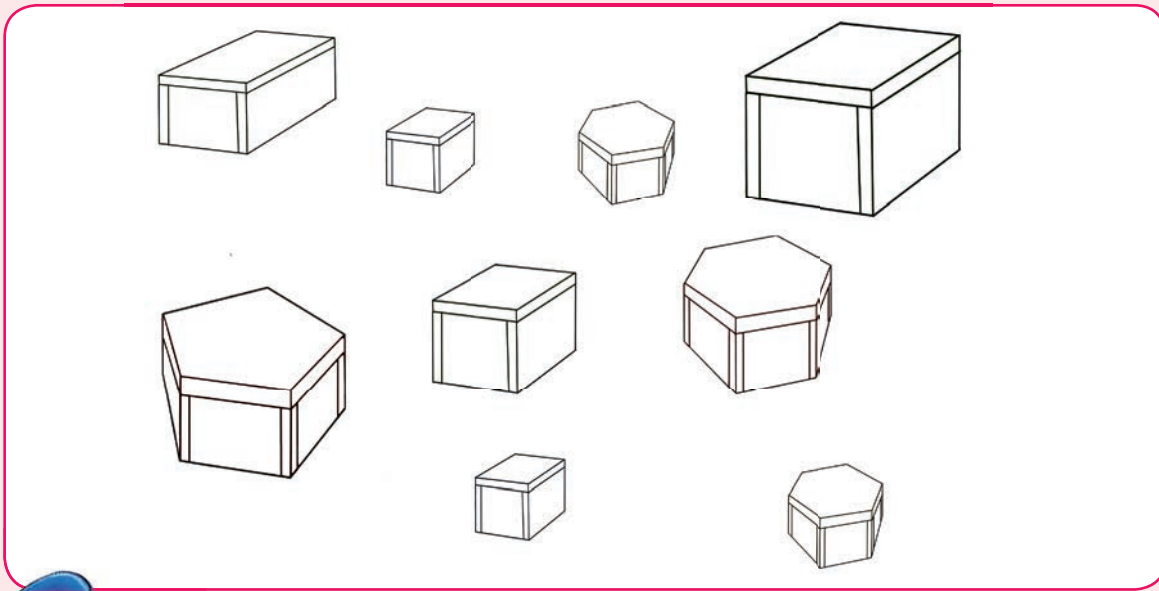
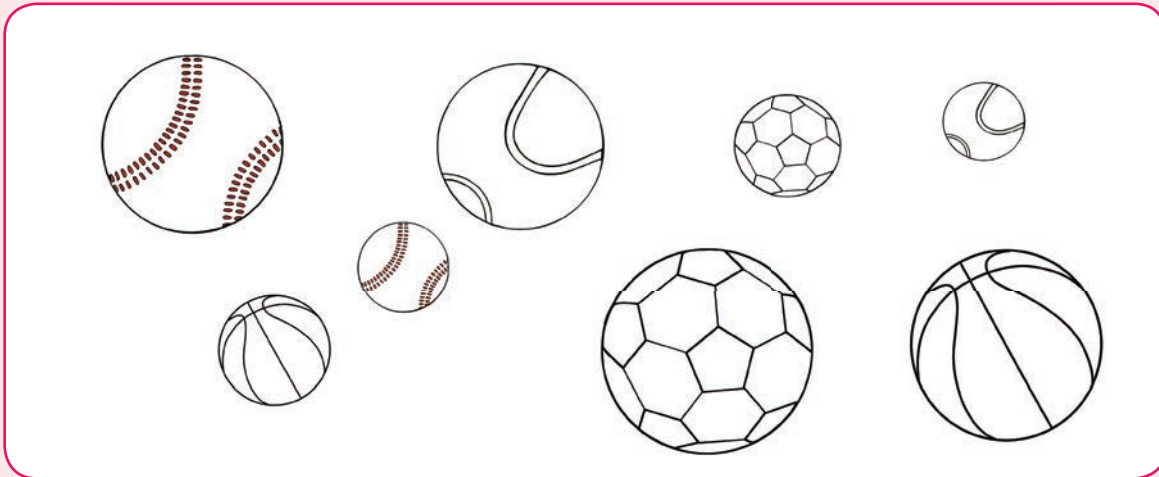

Trace the words.



Teacher:
Sign:
Date:





Left and right

Left hand

Right hand

	Left	Right
The tree is on his	<input type="checkbox"/>	<input type="checkbox"/>
The car is on his	<input type="checkbox"/>	<input type="checkbox"/>
The house is on his	<input type="checkbox"/>	<input type="checkbox"/>
The bird is on his	<input type="checkbox"/>	<input type="checkbox"/>
The nest is on his	<input type="checkbox"/>	<input type="checkbox"/>

	Left	Right
The dog is on his	<input type="checkbox"/>	<input type="checkbox"/>
The sheep is on his	<input type="checkbox"/>	<input type="checkbox"/>
The hut is on his	<input type="checkbox"/>	<input type="checkbox"/>
The school is on his	<input type="checkbox"/>	<input type="checkbox"/>
The flower is on his	<input type="checkbox"/>	<input type="checkbox"/>



Circle his right hand.
 Circle his right foot.
 Stand like the boy and show
 your right hand.

Circle her right hand.
 Circle her left foot.
 Stand like the girl and show your
 left hand.

Right

Left



Right

Left

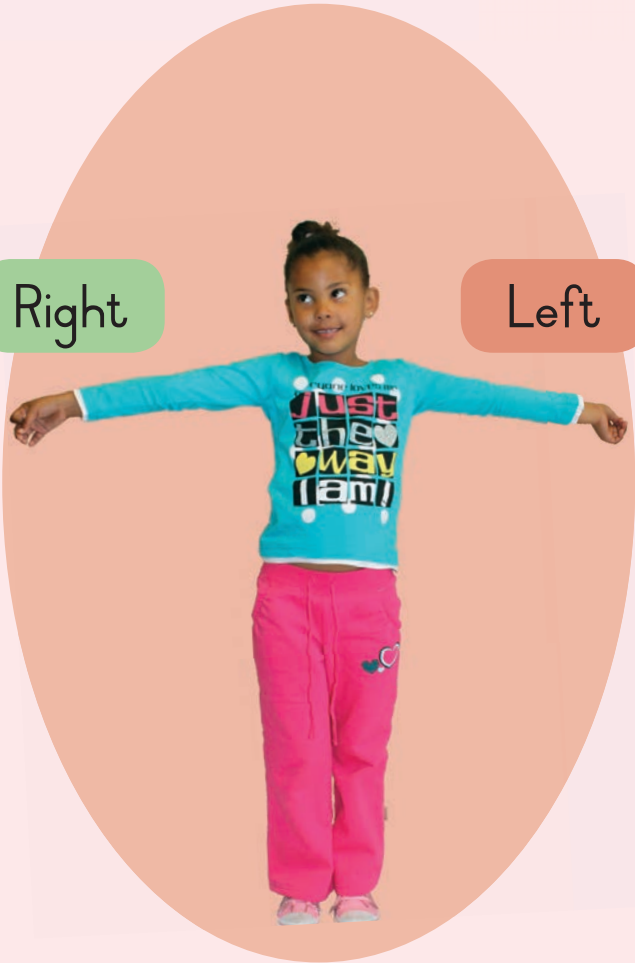

Count and write the number of dots in each box.

Three orange dots in a row.

A dotted number 3 for tracing.

Five blue dots in a row.

Two red dots in a row.

Four green dots in a row.



Teacher:
 Sign:
 Date:





Direction

Help the rabbit find the carrots. Should it turn **left** or **right**?



left	right
<input checked="" type="checkbox"/>	<input type="checkbox"/>



left	right
<input type="checkbox"/>	<input type="checkbox"/>

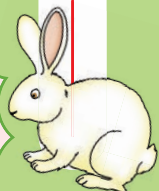

left	right
<input type="checkbox"/>	<input type="checkbox"/>

left	right
<input type="checkbox"/>	<input type="checkbox"/>





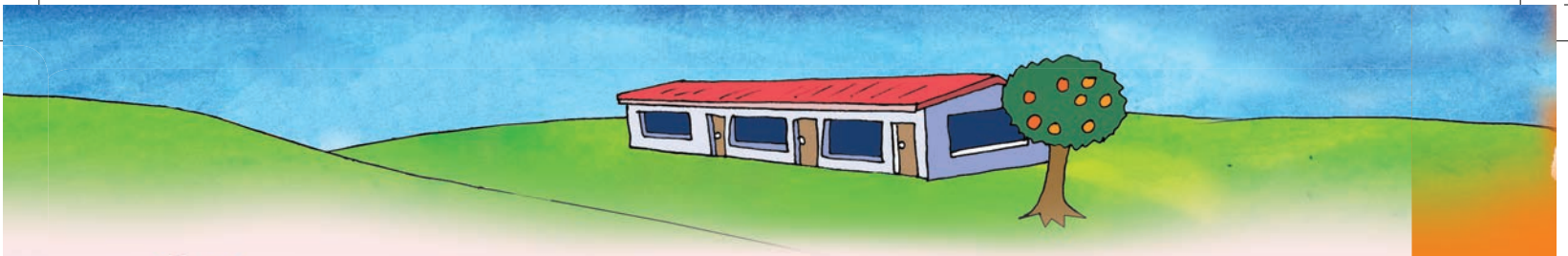

left	right
<input type="checkbox"/>	<input type="checkbox"/>

























Colour the correct word that matches the arrow.

	above	left	below	right
	above	left	below	right
	above	left	below	right
	above	left	below	right



Circle the correct arrow that matches the first one in the row.



Teacher: _____
Sign: _____
Date: _____





Building up and breaking down numbers

Fill in the correct numbers in each block.



and is



and is



and is



and is

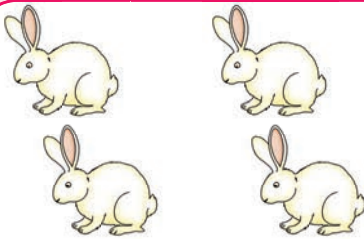

and is



and is



and is



and is



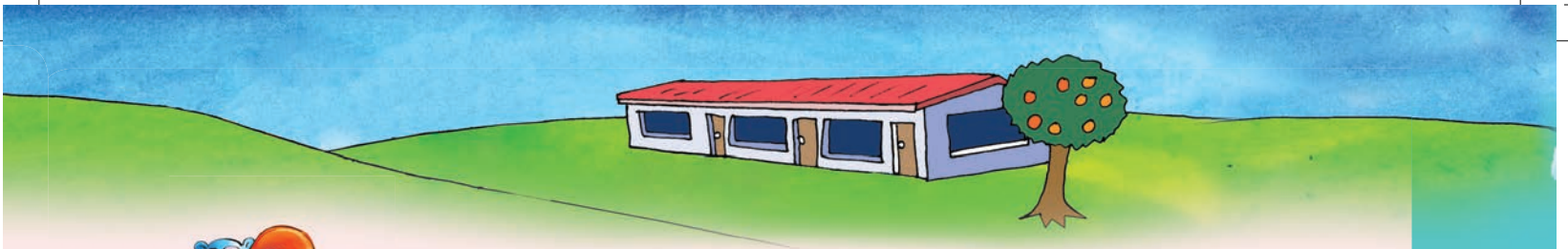

Now try these.



and and is

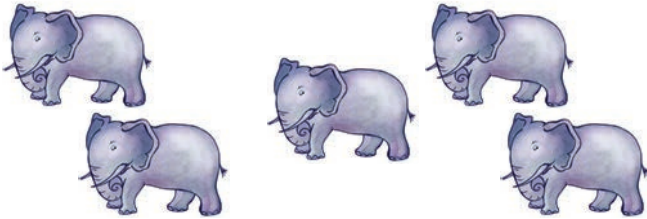

and and is



and and is

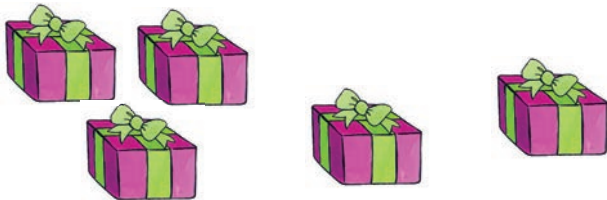

and and is



and and is

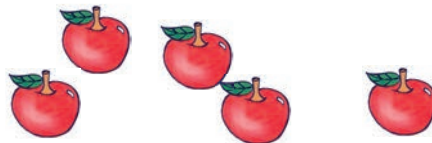

and and is



Teacher:
Sign:

Date:





Addition doubles

Double the dots on the wings.

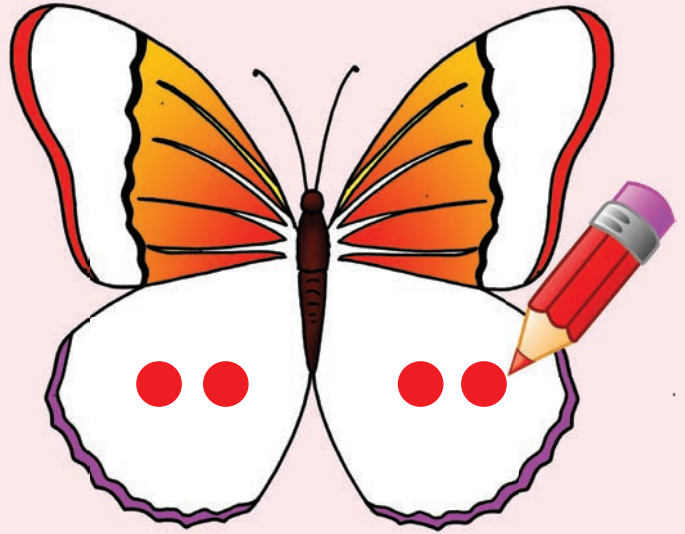
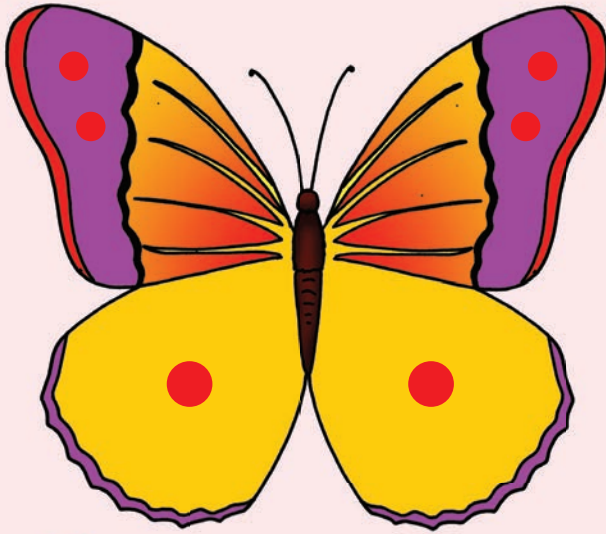

Double the shapes.

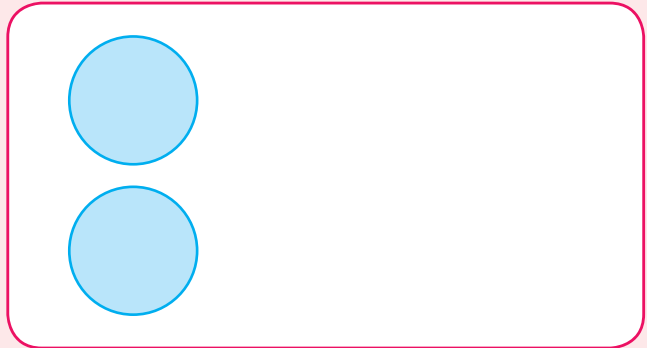
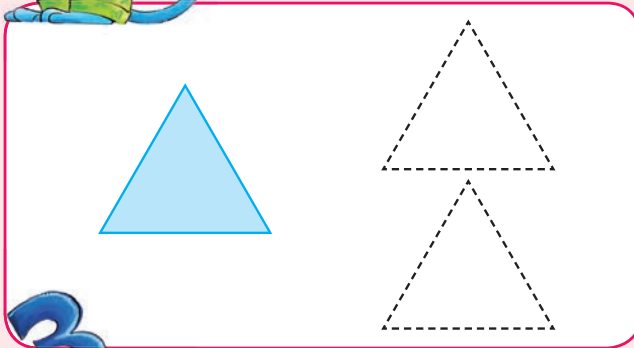

Draw and then fill in the numbers.

Double  is   Double is

Double  is Double is

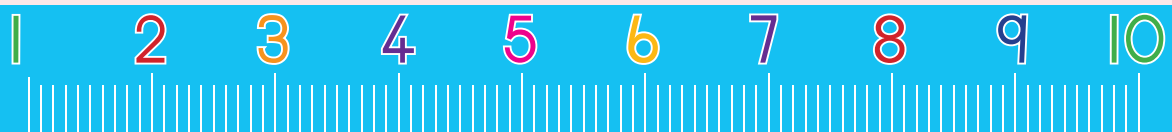

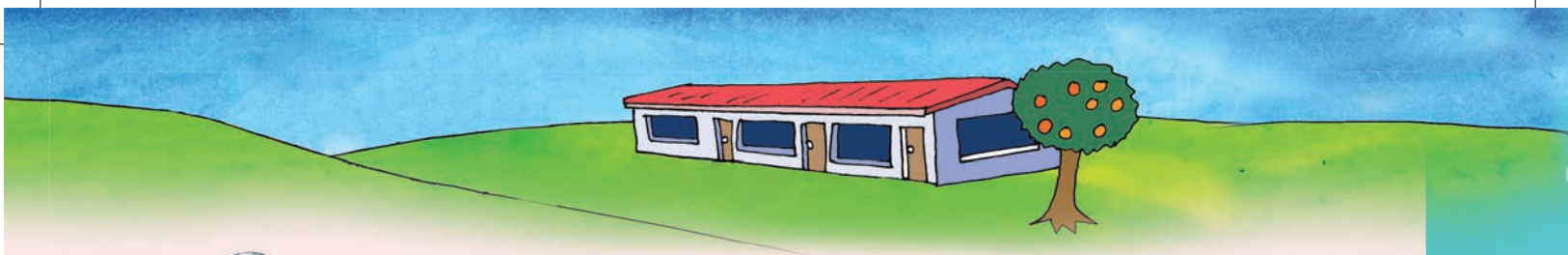



Draw and then fill in the numbers

Double  is  

Double is

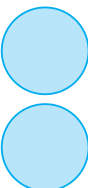
plus is

Double  is 

Double is

plus is



Show the following on the number lines.

Double 1 is

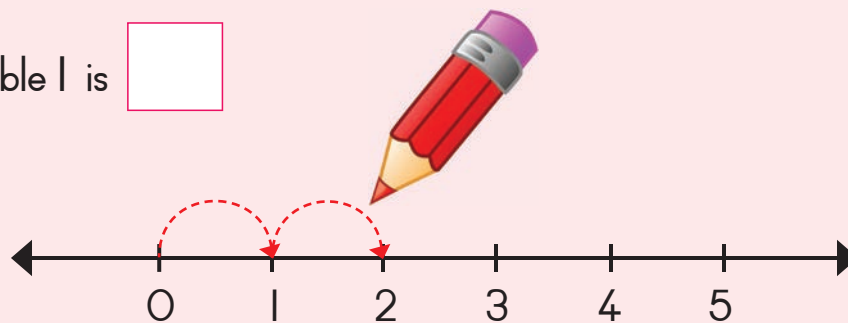

Double 2 is

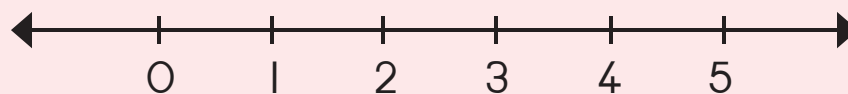

Teacher: _____
Sign: _____
Date: _____





Bigger and smaller

- Put a circle around the biggest animal and
- Draw a square around the smallest animal in each box.

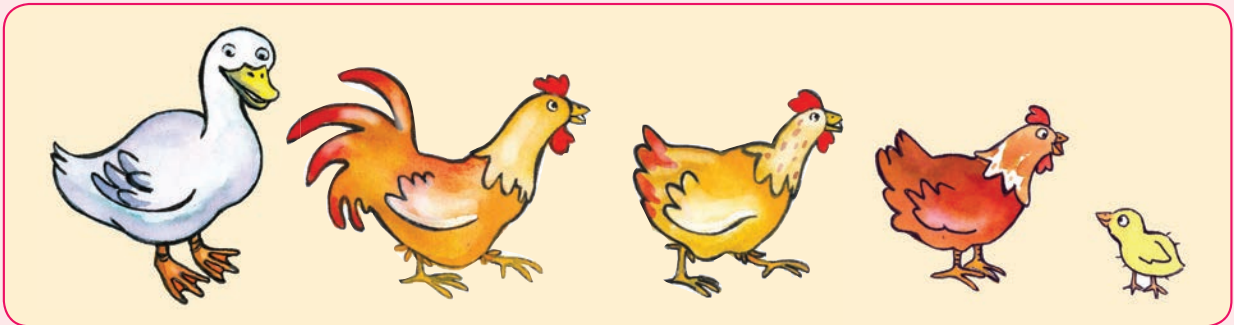
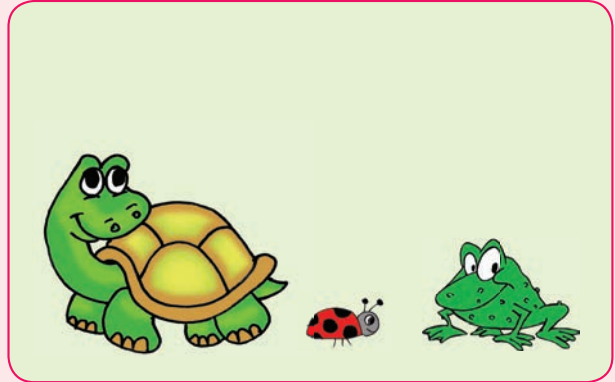
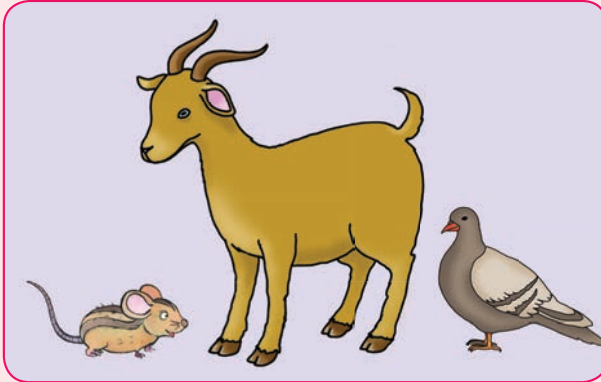
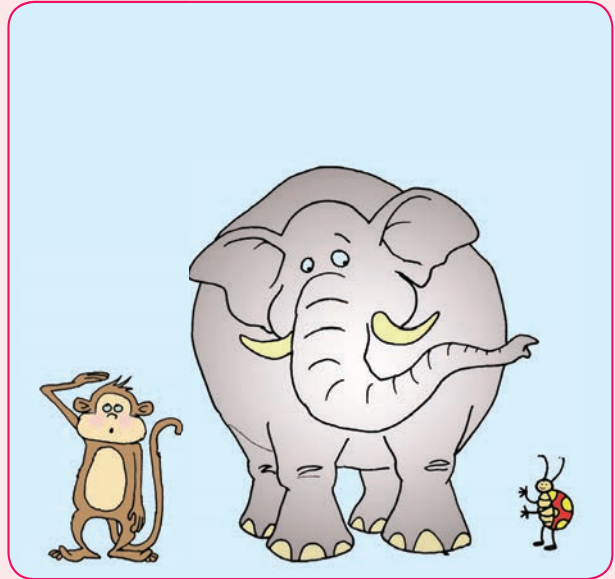
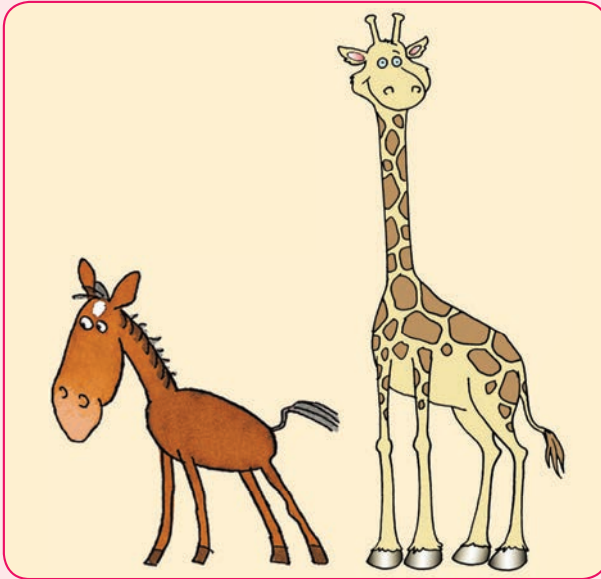

big small

biggest

smallest

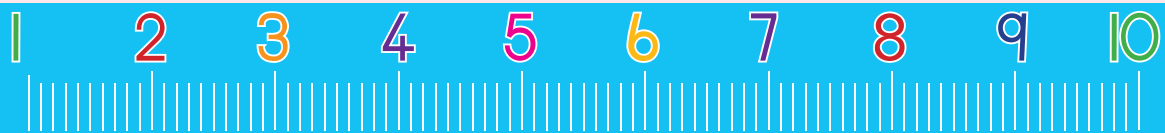

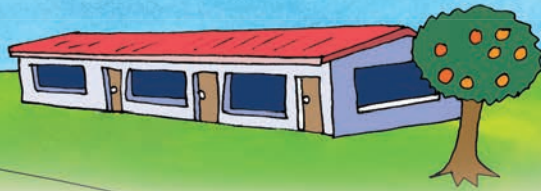

Draw a bigger ball.

Draw a smaller ball.



Draw a smaller box.

Draw a bigger box.

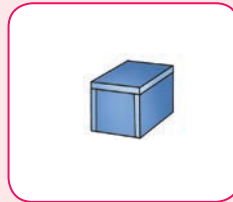
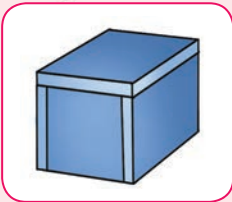

Colour the smallest box and ball.

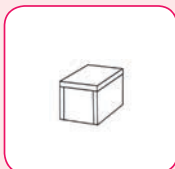
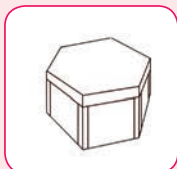
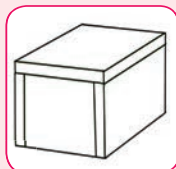

Colour the biggest ball and box.

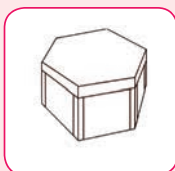
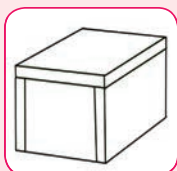
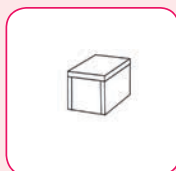

Teacher:
Sign:
Date:





Sort objects

Match the sorted objects with the picture.

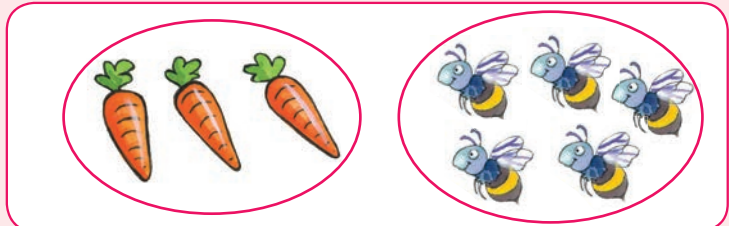
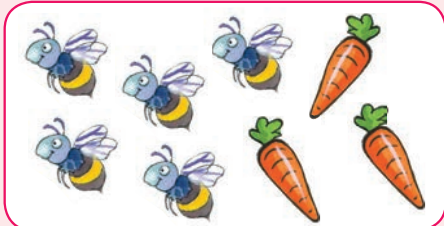

Sort by making a drawing of each.

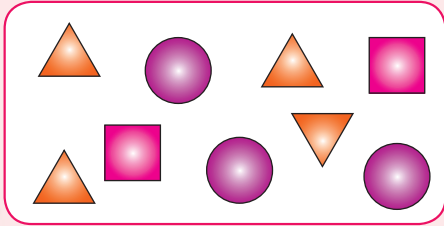
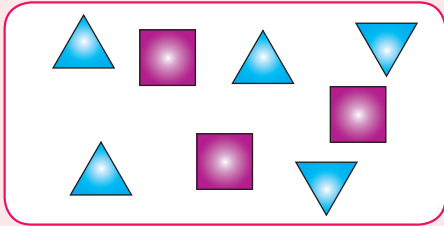
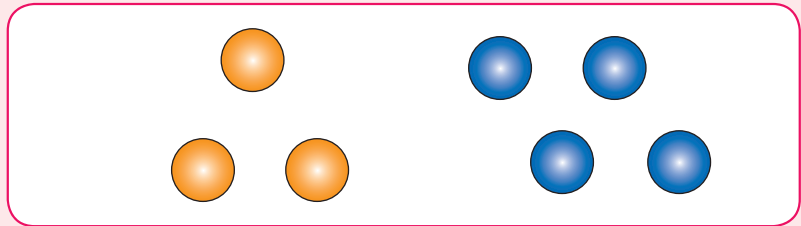
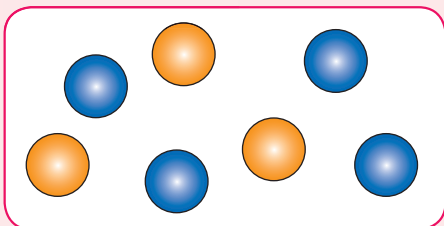

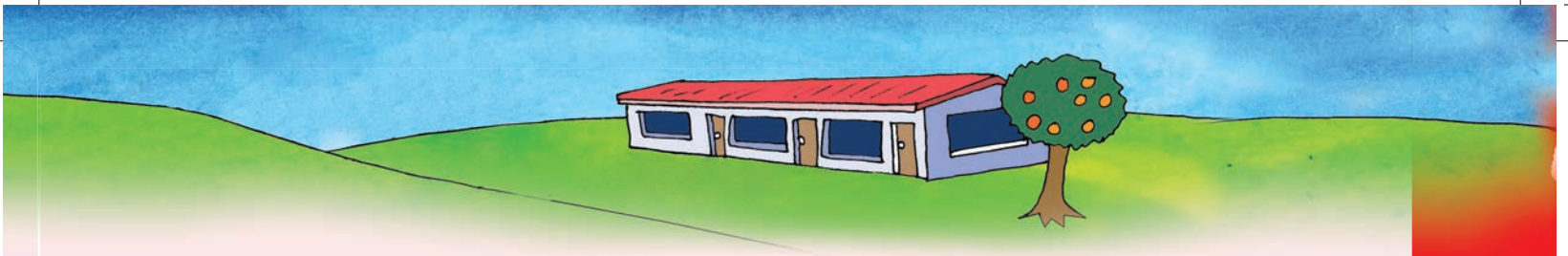

Count the number of different shapes in the block. Then draw and colour in the same number of shapes in the picture graph and write the number of each at the bottom.

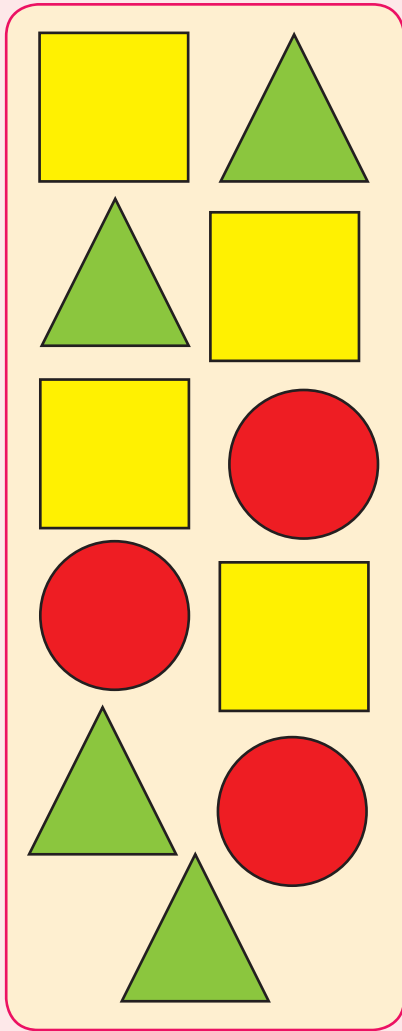



Teacher: _____
Sign: _____
Date: _____





Let us share equally

Count the oranges, bananas and apples and write the numbers in the blocks.

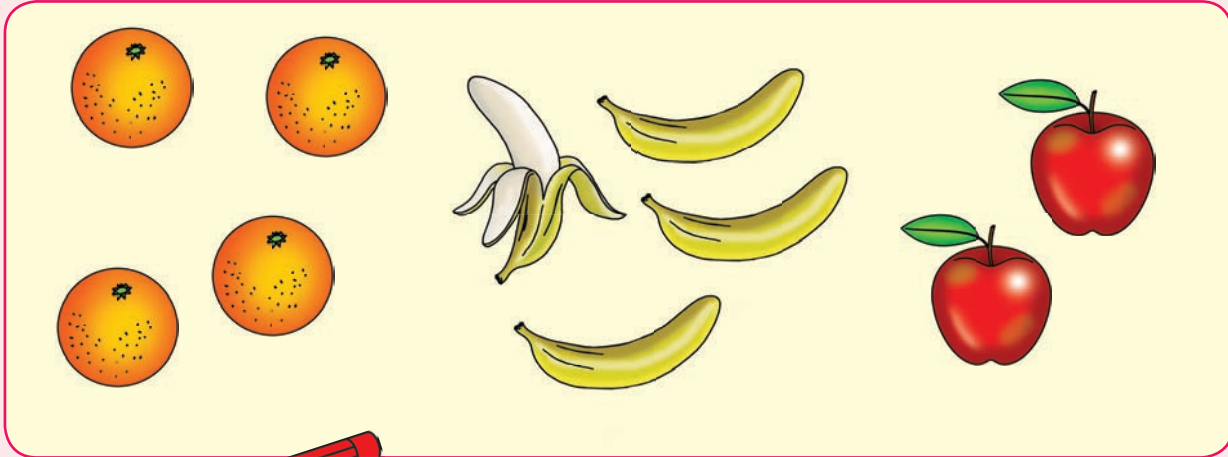

4

oranges



bananas



apples

Share the fruit you counted equally between two children. Draw the fruit each child gets.

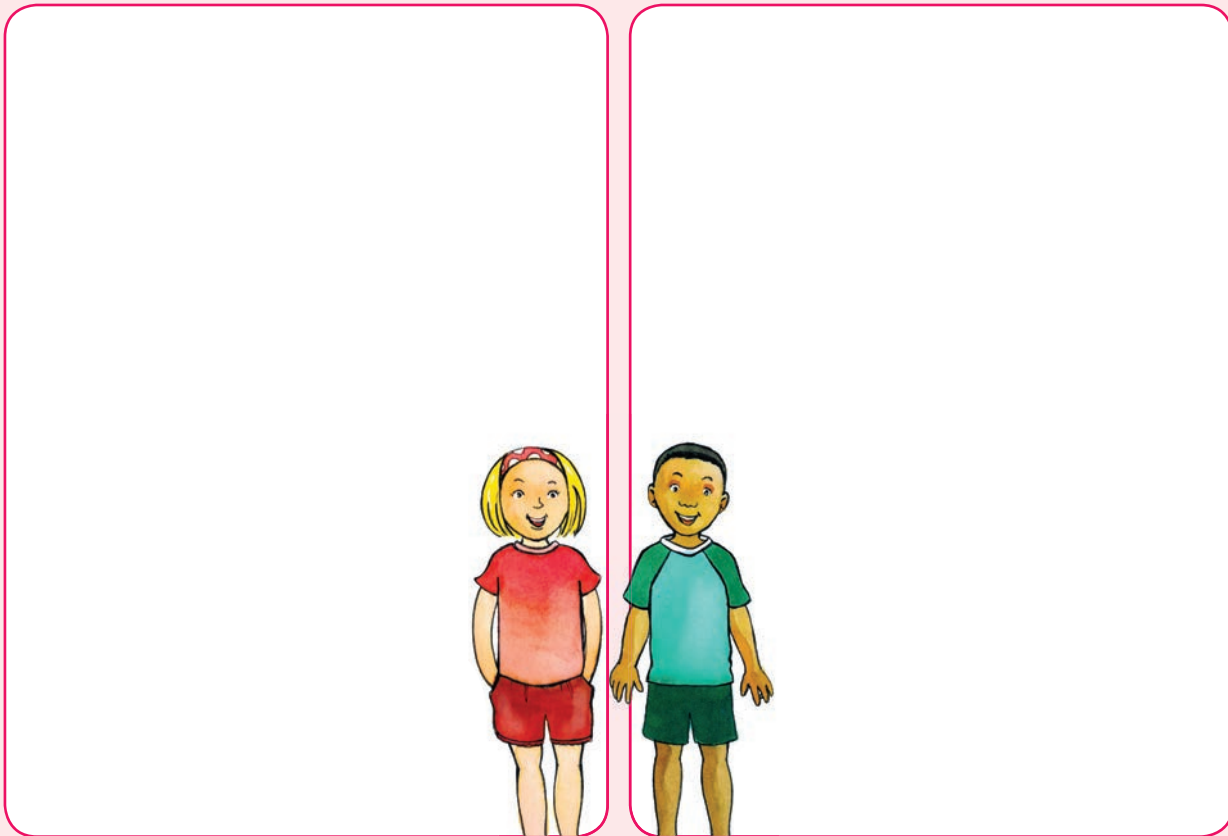

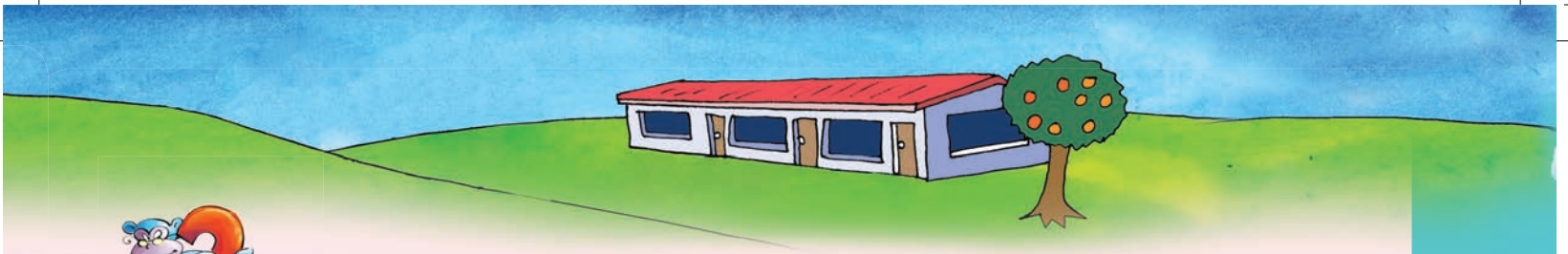

Share the objects between the two boxes. Draw the two groups in the separate boxes.

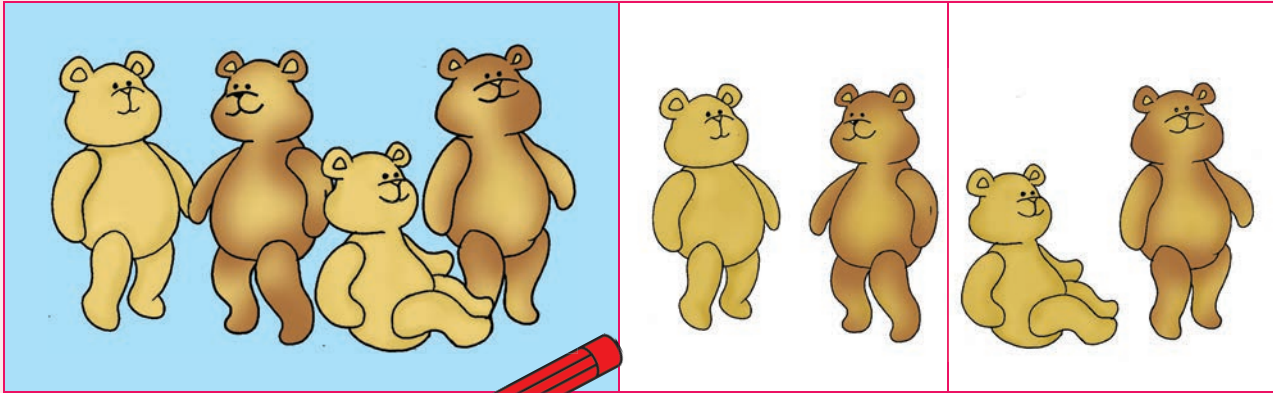

$$4 = 2 + 2$$



$$\square = \square + \square$$

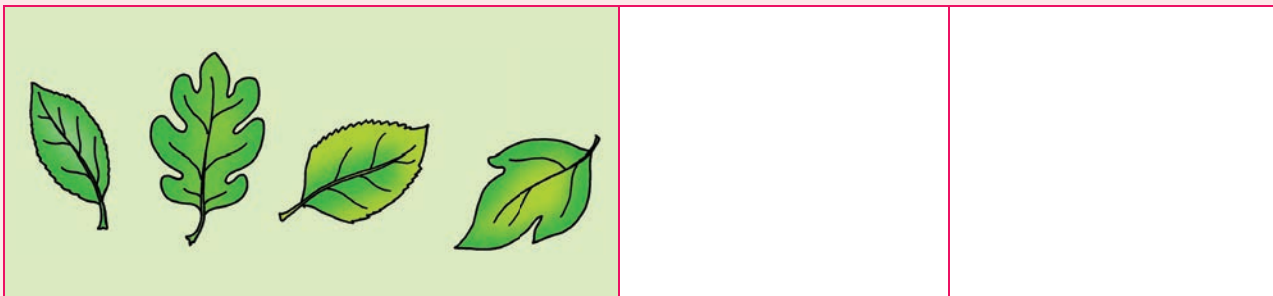

$$\square = \square + \square$$



Teacher:
Sign:
Date:





Sharing and grouping

Circle the fruit and animals to share them equally.

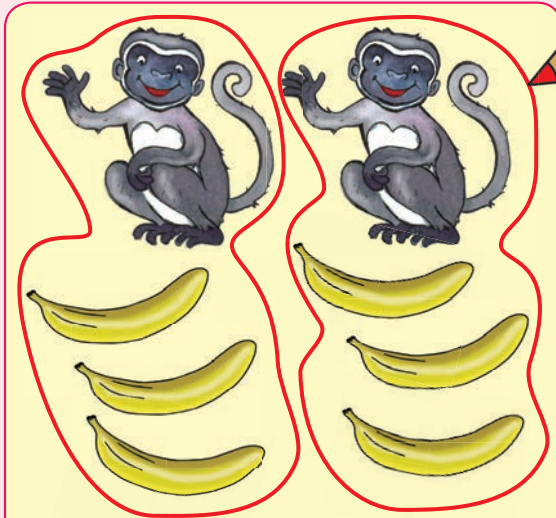

How many bananas did each monkey get?

3

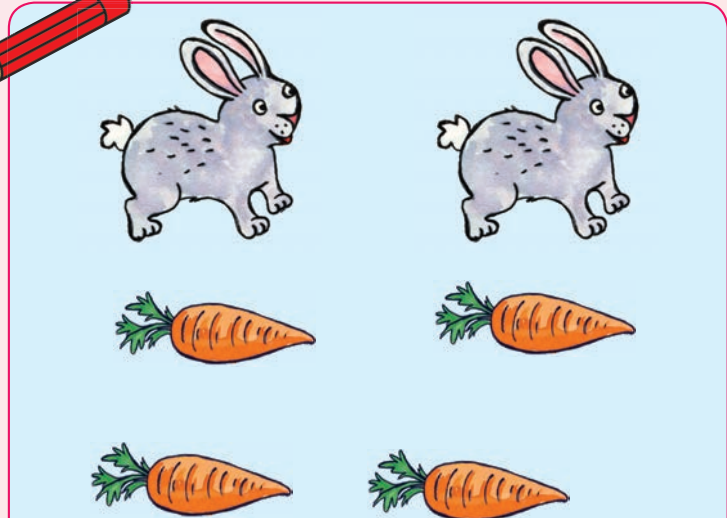

How many carrots did each rabbit get?

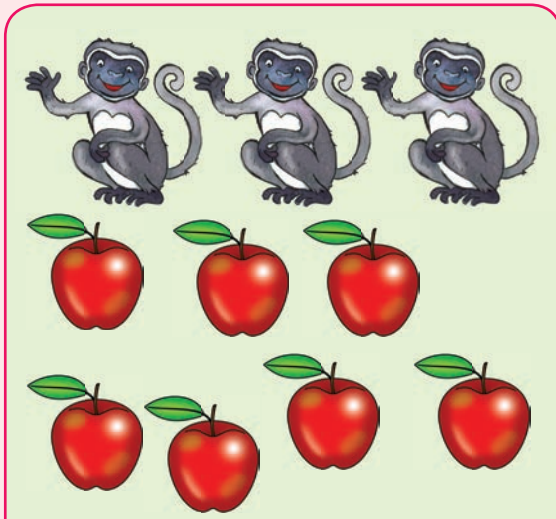

How many apples did each monkey get?

Were there any apples left over after sharing them equally?

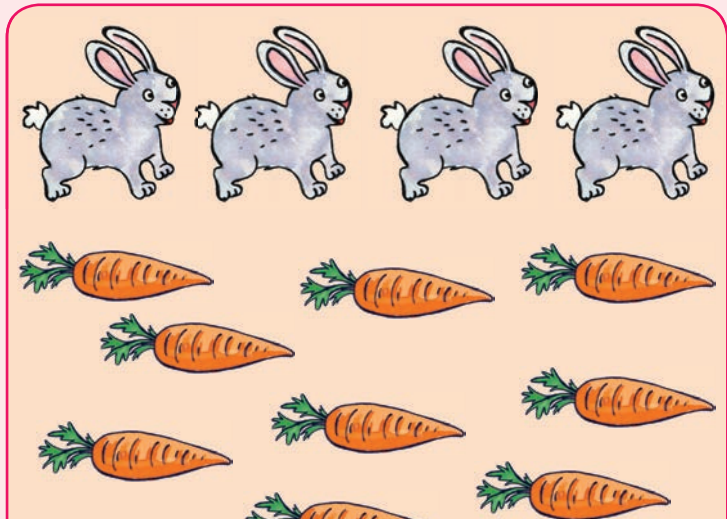

How many carrots did each rabbit get?

Were there any carrots left over after sharing them equally?



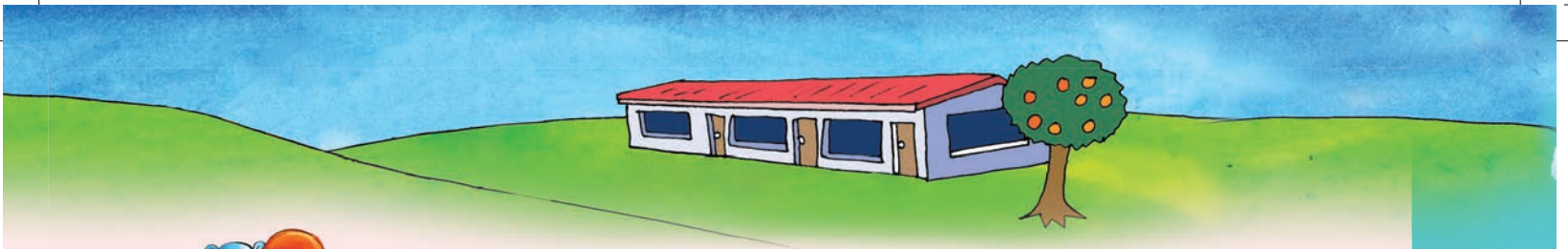

Group the counters into two equal groups and put a cross on the remaining counters.

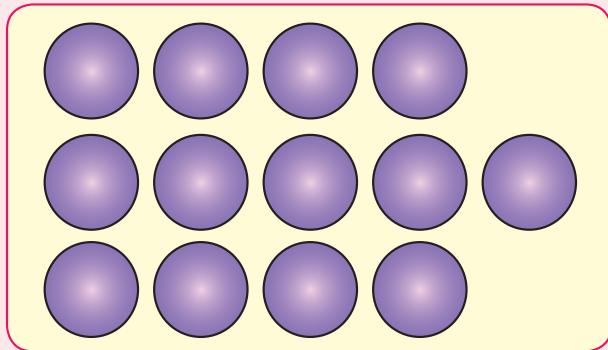
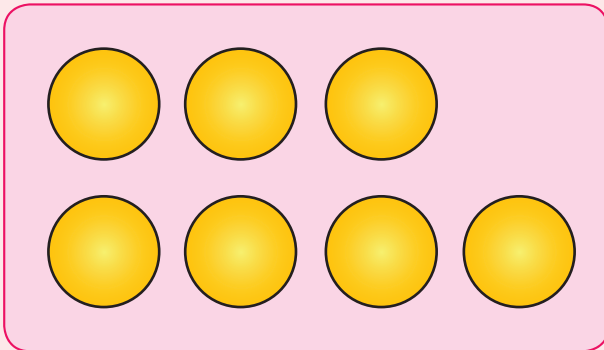
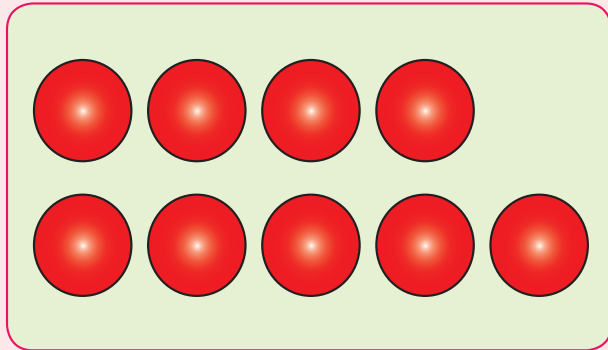
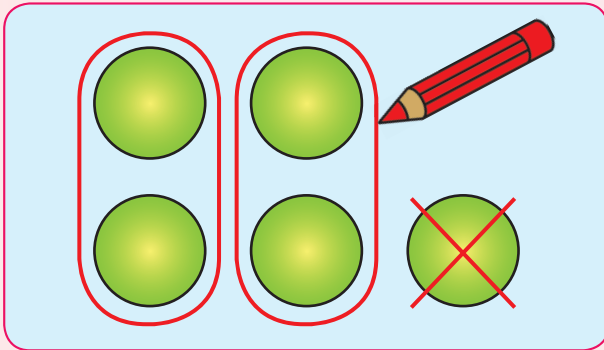

Put the counters into 3 equal groups and put a cross on the remaining counters.

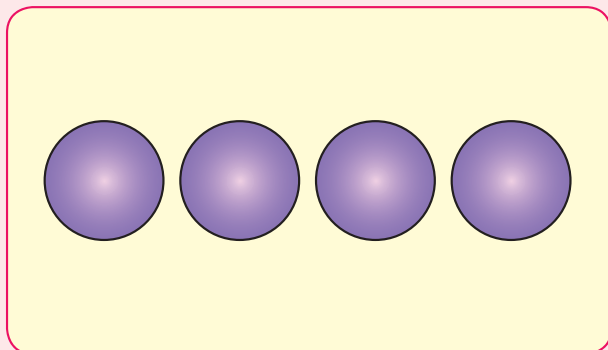
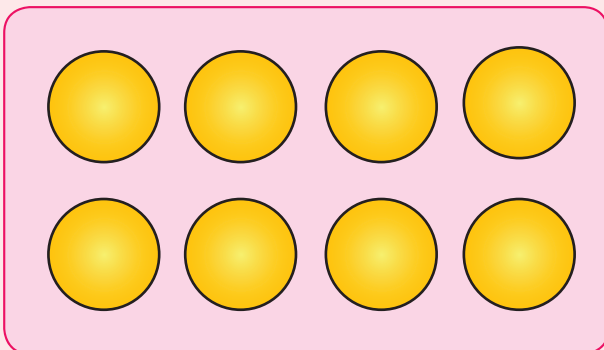
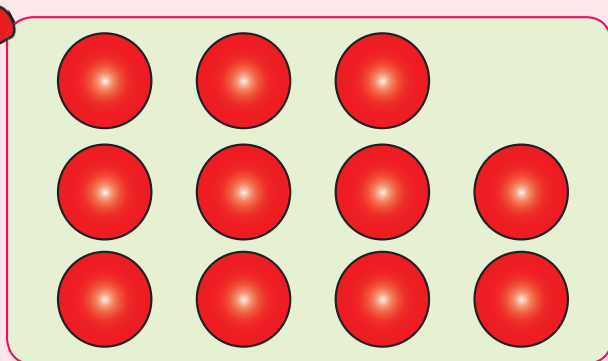
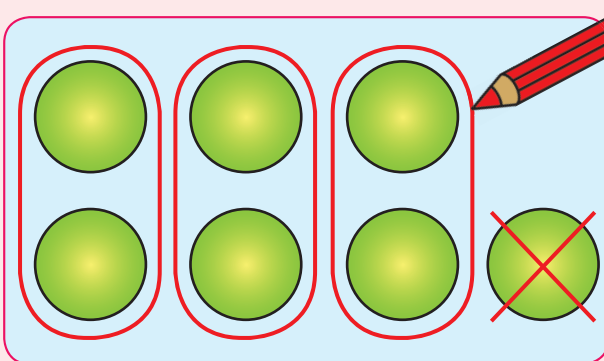

Teacher:
Sign:
Date:





Building objects

Can you build a tower with all the following objects?
Tick yes or no.

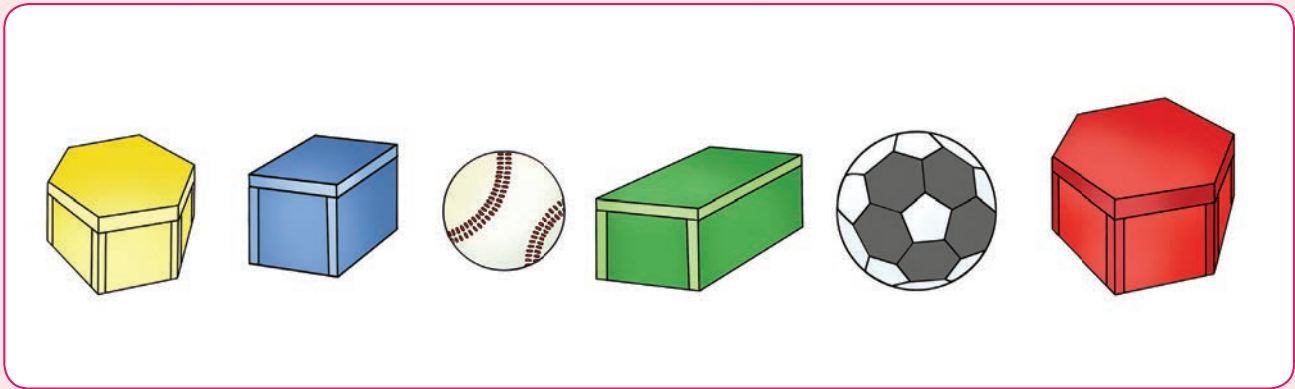

Yes

No

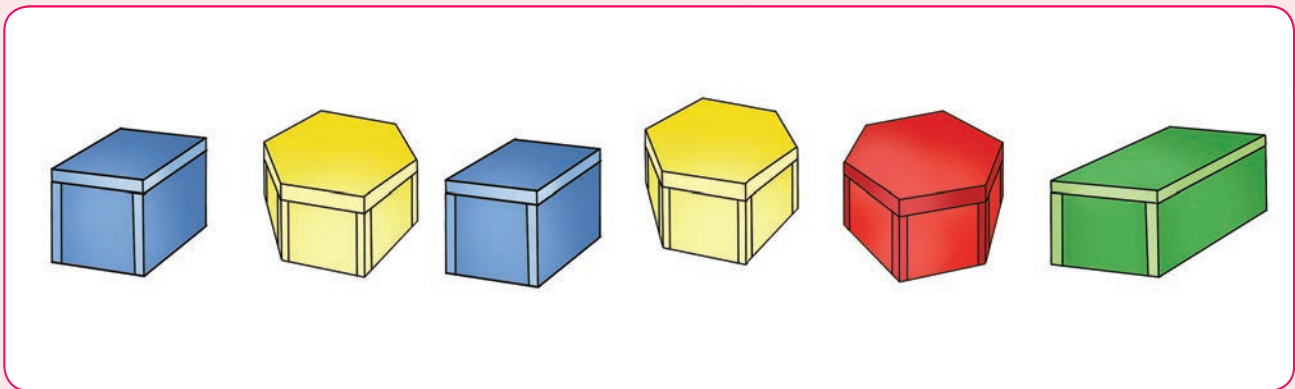

Yes

No



Yes

No



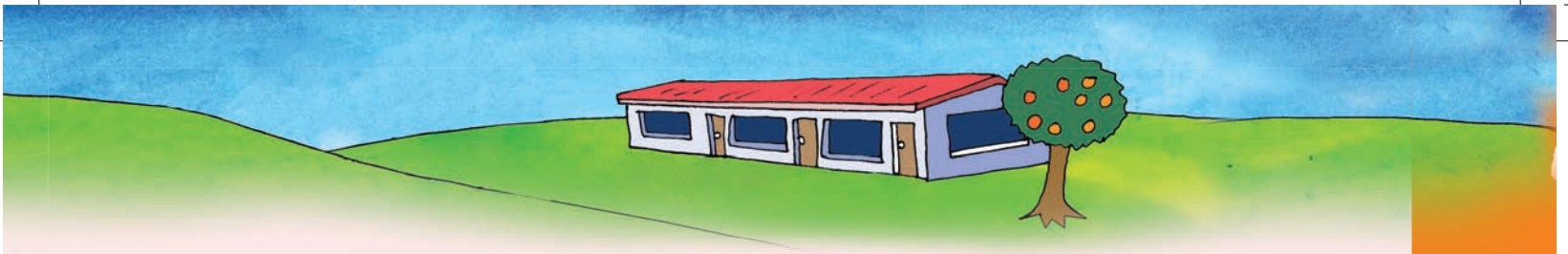

Will the tower stand or not? Put a ✓ or a ✗.

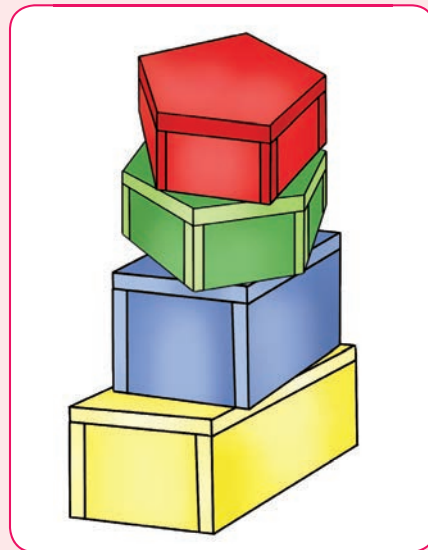
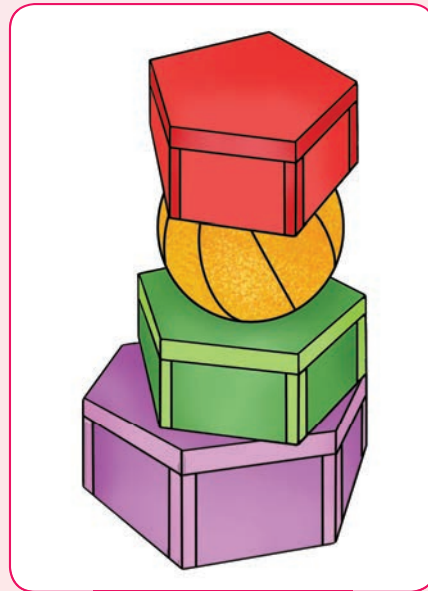
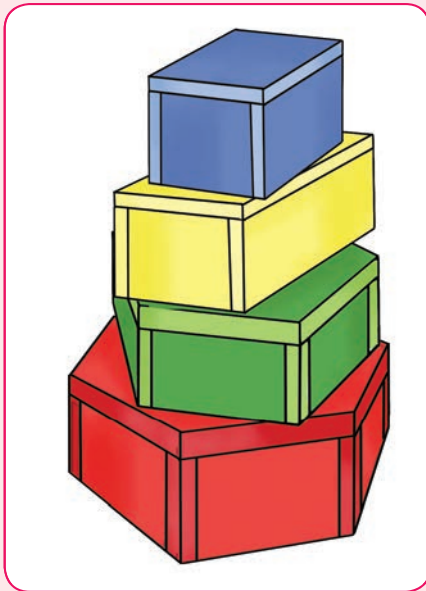

Use ten matchboxes and glue to make your own building.
Does glue make it easier?



Teacher:
Sign:
Date:



Trace the months of the year.
Colour in your birthday month balloon.

Telling time



January

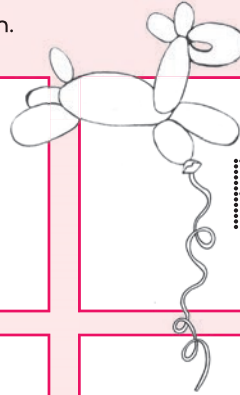

February

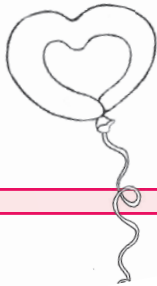

March

April

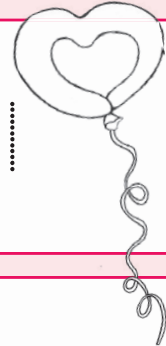

May

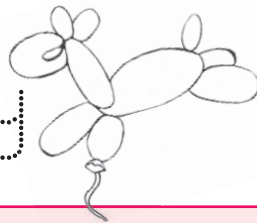

June



July

August



September



October

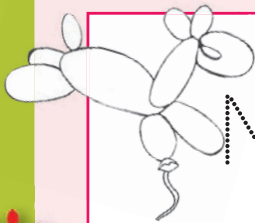

November

December

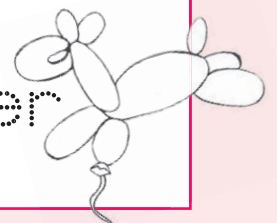



Trace the days of the week.
Colour in the block for the day it is today.



Monday



Tuesday



Wednesday



Thursday



Friday



Saturday

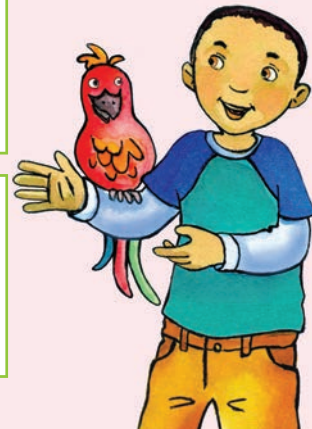

Teacher:

Sign:

Date:



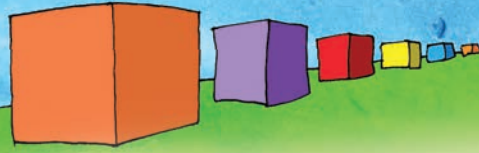

Six



Draw 6 circles in the block.

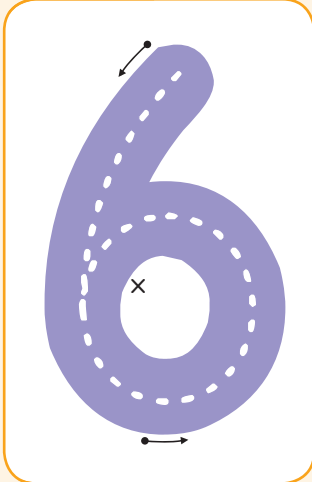

Trace the number.



Match the pictures.

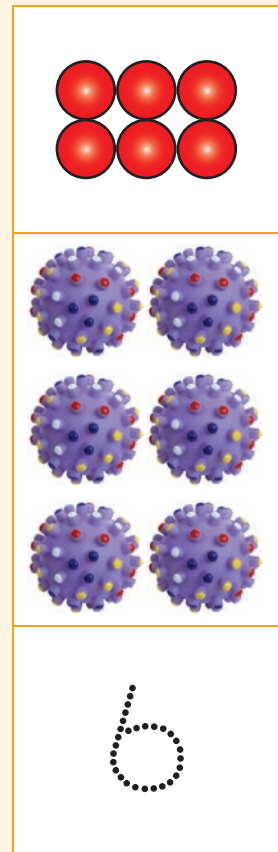
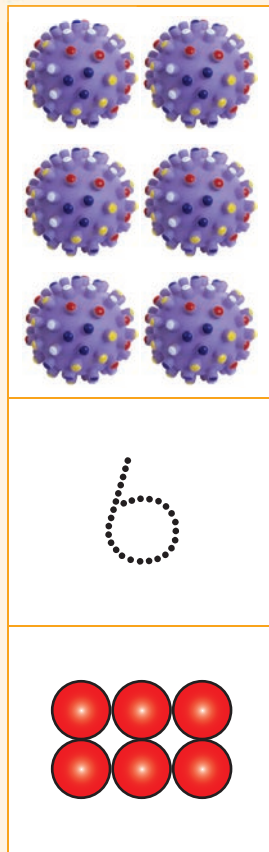
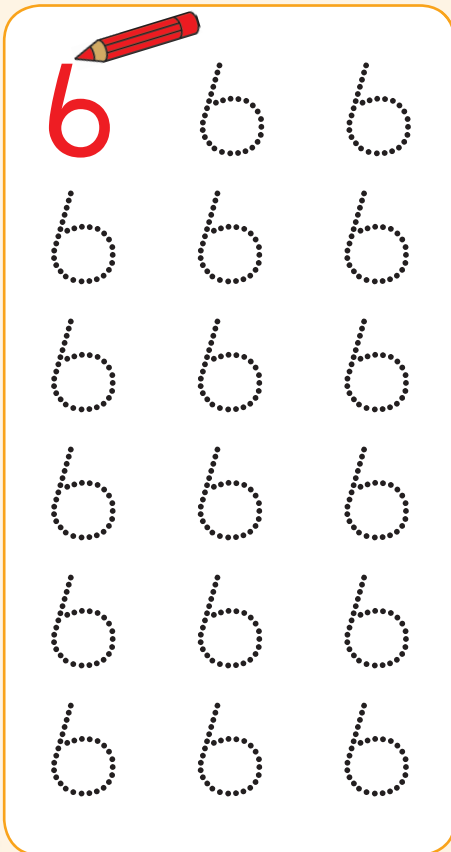



Colour in 6 circles.

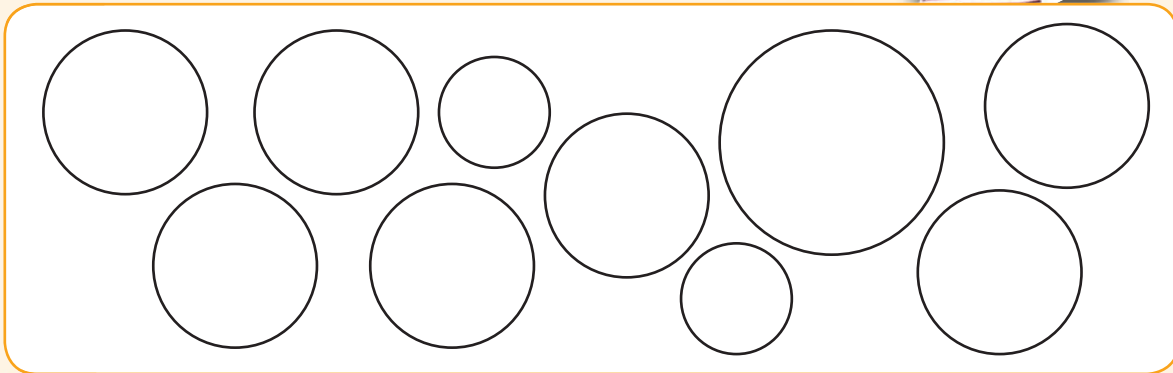

Copy and draw 6 more.



Practise the number.



six



Colour the circles as you count.

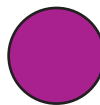

Teacher: _____
 Sign: _____
 Date: _____



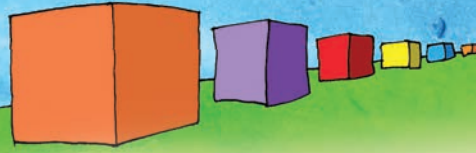

Seven



Draw 7 squares in the block.



Trace the number.



Match the pictures.

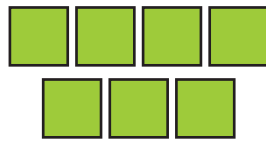
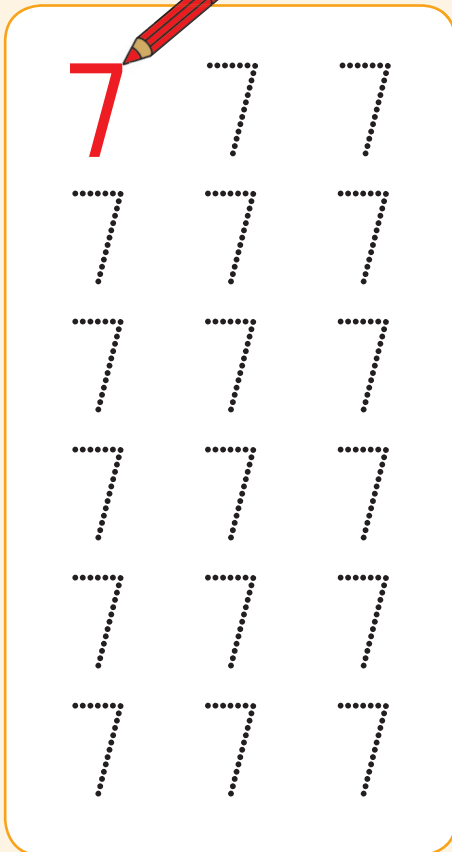

seven

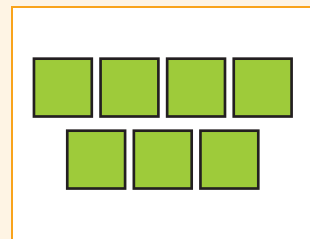

seven





Colour in 7 rectangles and 7 blocks.

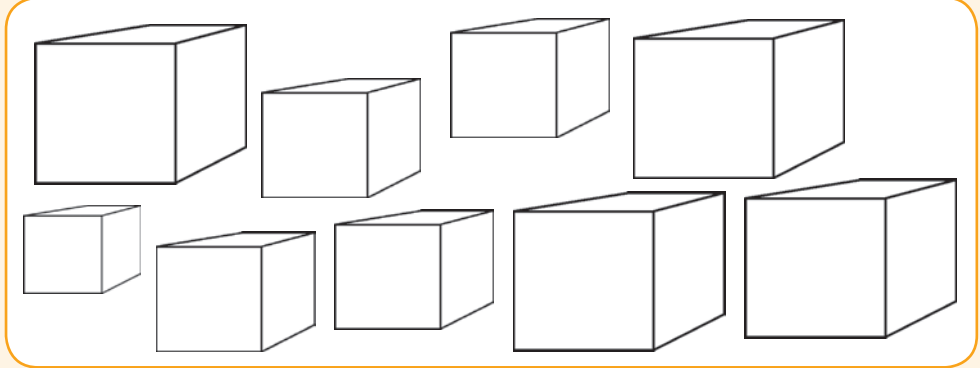
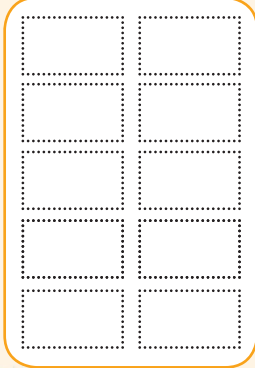

Copy and draw 7 more.

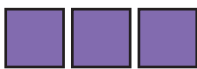

Practise the number.



seven



Colour the squares as you count.



Teacher:
Sign:
Date:

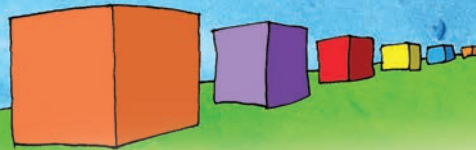

Eight



Draw 8 shapes in the block.

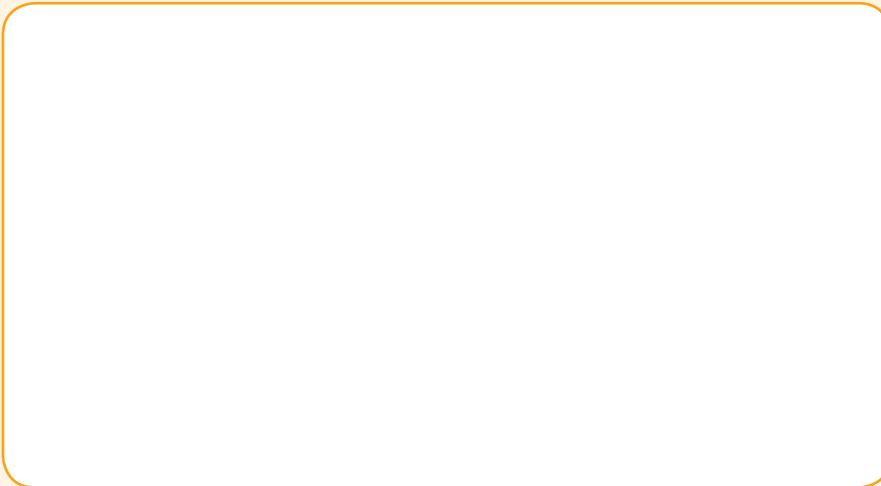
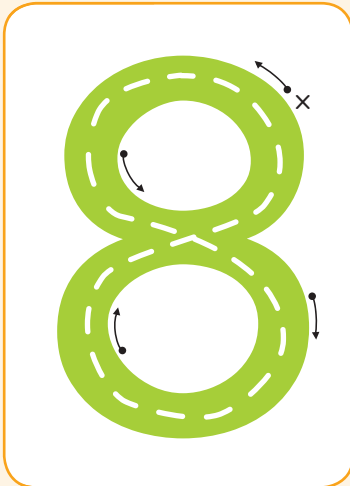

Trace the number.



Match the pictures.

Tracing practice for the number 8. It consists of three columns of eight dotted numbers 8 each, for a total of 24 numbers to trace.

A matching exercise with four boxes. The top box contains four colored pencils. The second box contains a pair of hands showing eight fingers. The third box contains a dotted number 8. The bottom box contains seven colored circles.

A matching exercise with four boxes. The top box contains seven colored circles. The second box contains a dotted number 8. The third box contains a pair of hands showing eight fingers. The bottom box contains four colored pencils.





Colour in 8 stars.



Copy and draw 8 more.

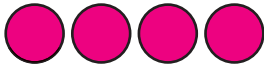

Practise the number.



eight



Colour the circles as you count.

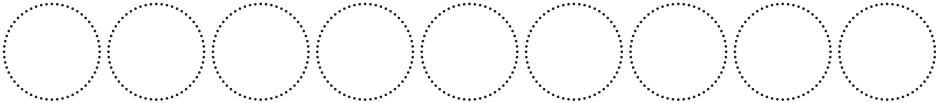
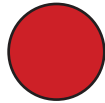

Teacher:
Sign:
Date:

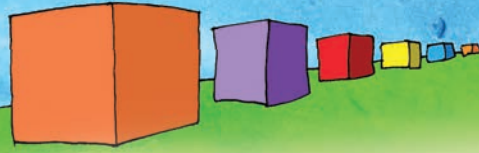

Nine



Draw 9 hearts in the block.

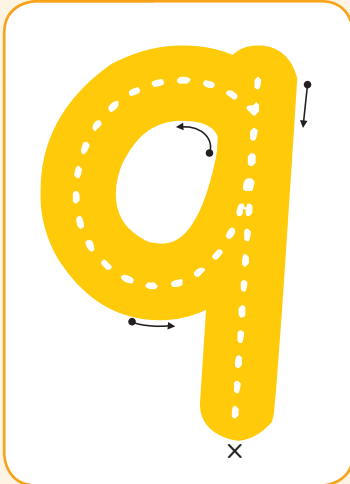

Trace the number.



Match the pictures.

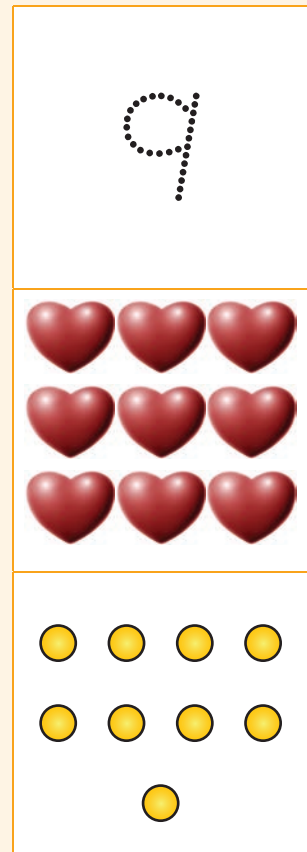
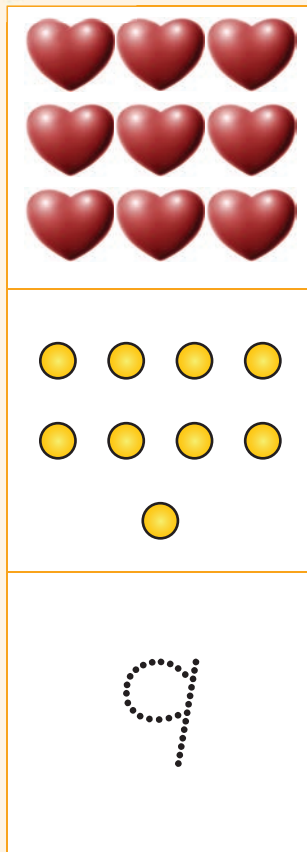
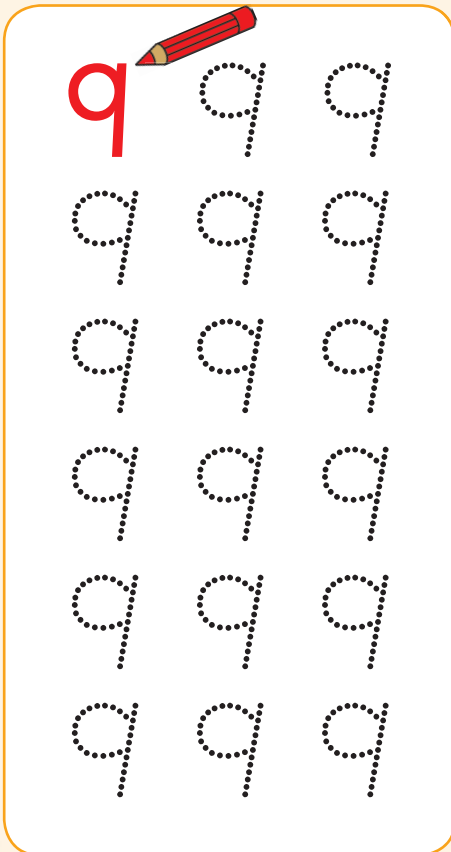



Colour in 9 balloons.

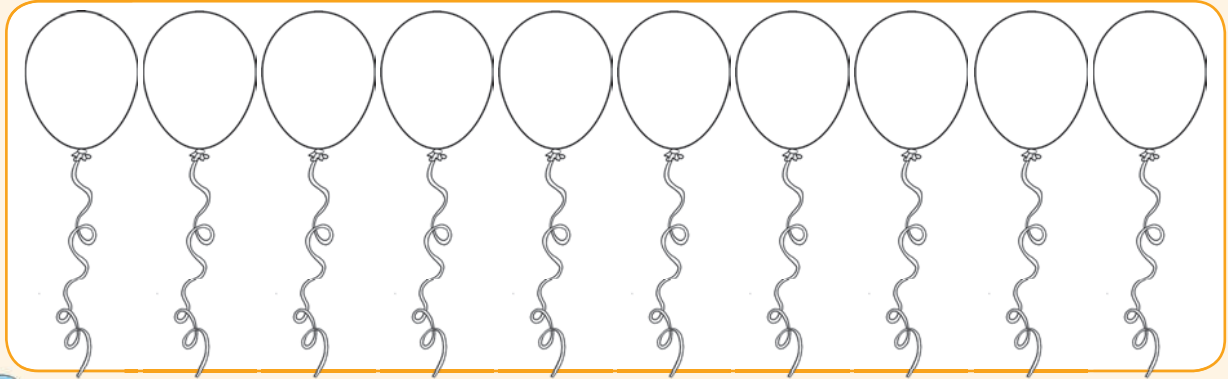

Copy and draw 9 more.

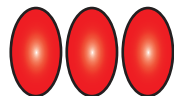

Practise the number.



nine



Colour the triangles as you count.

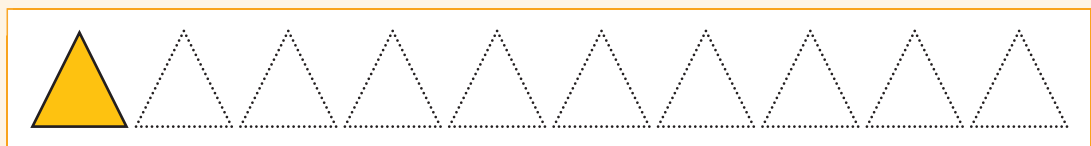

Teacher:
Sign:
Date:



Full or empty

Colour in the correct answer.
Are the containers full or empty?



empty full

empty full

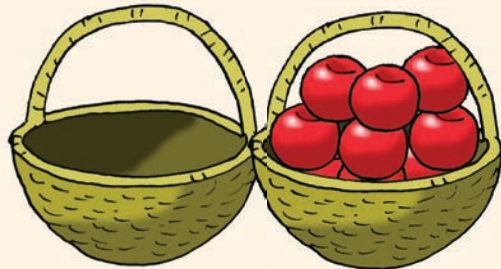

empty full

empty full

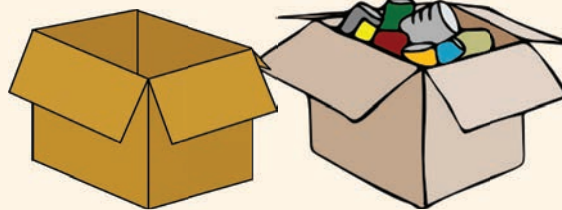

empty full

empty full



empty full

empty full

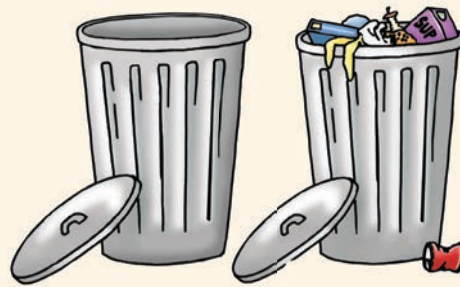

empty full

empty full



empty full

empty full



empty full

empty full

full

empty





Colour in the correct answer.
Are the containers full or empty?

empty full

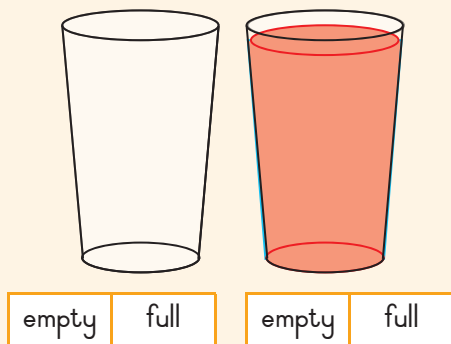
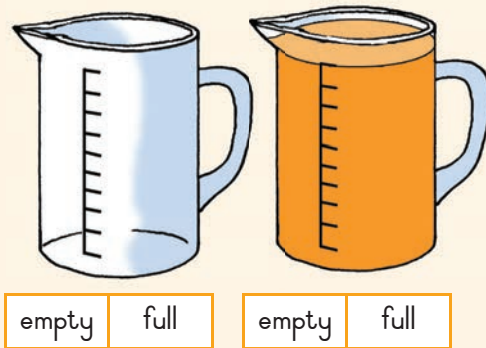
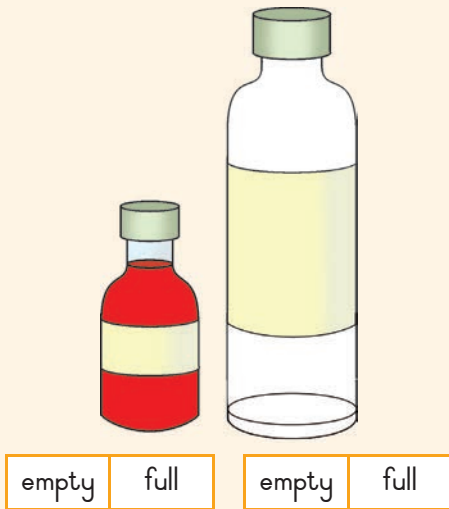
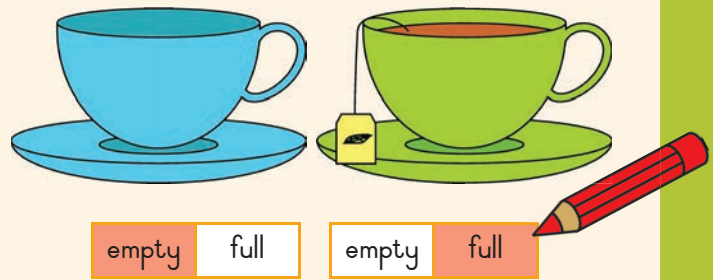

Teacher:
Sign:
Date:

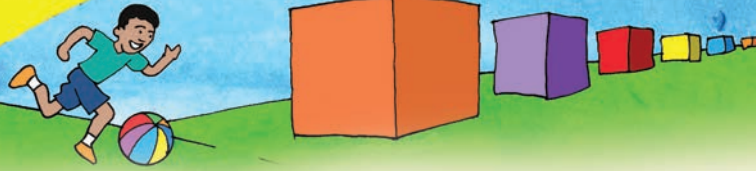

Ten



Count the fingers on both your hands.

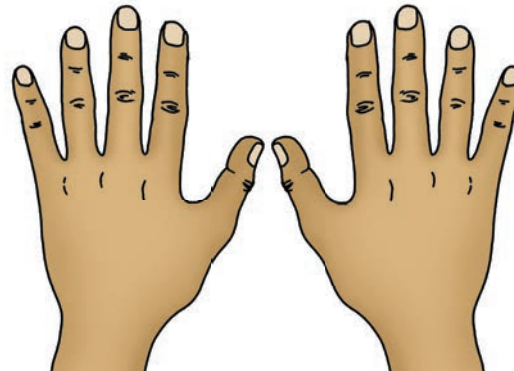
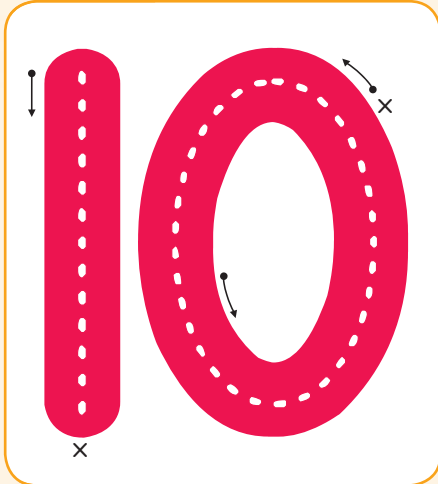

Trace the number.



Match the pictures.

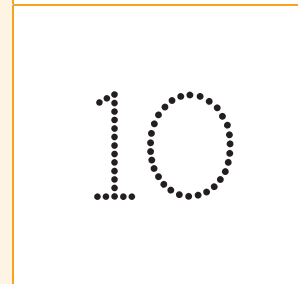
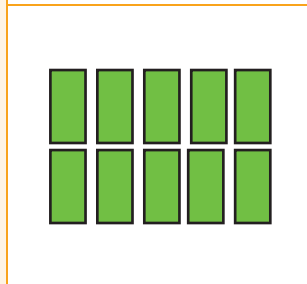
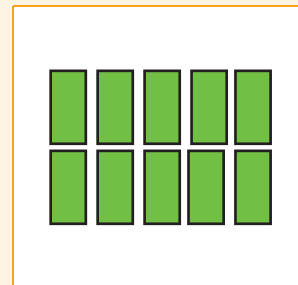
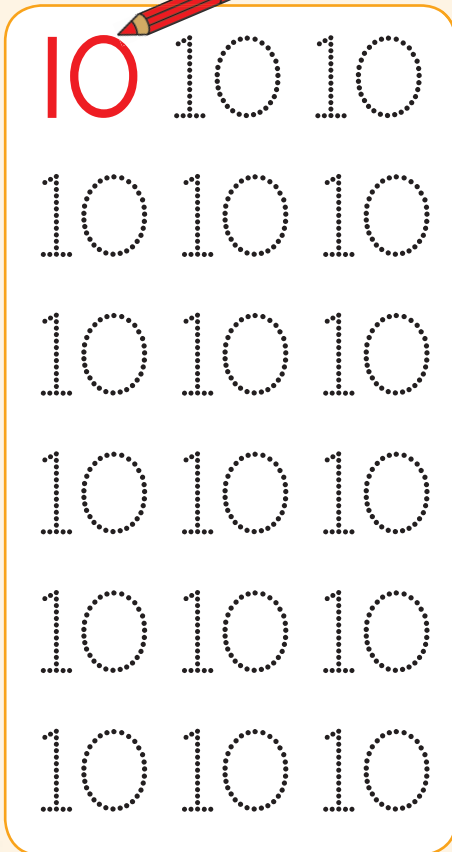



Colour in 10 fruit.



Copy and draw 10 more.



Practise the number.



ten



Colour the rectangles as you count.











Teacher: _____
Sign: _____
Date: _____



Numbers 1 to 10

Use your fingers to make these numbers. Then copy the numbers.

	1	1
	2	2
	3	3
	4	4
	5	5
	6	6
	7	7
	8	8
	9	9
	10	10



Writing numbers 6 to 10



Practise writing these numbers.



6

six



6

6

6



7

seven

7 7



8

eight

8 8

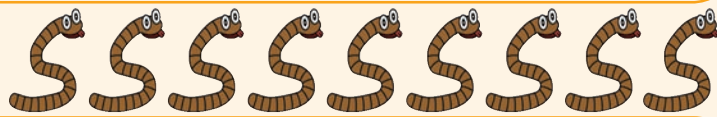

9

nine

9 9



10

ten

10 10



Teacher: _____
Sign: _____
Date: _____



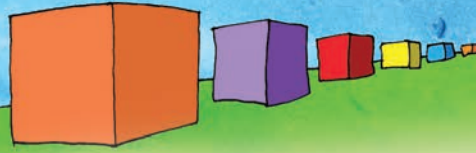

Capacity and volume

Draw more water in the container on the right.

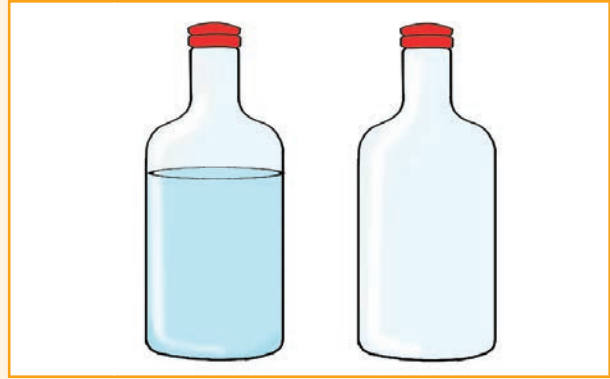
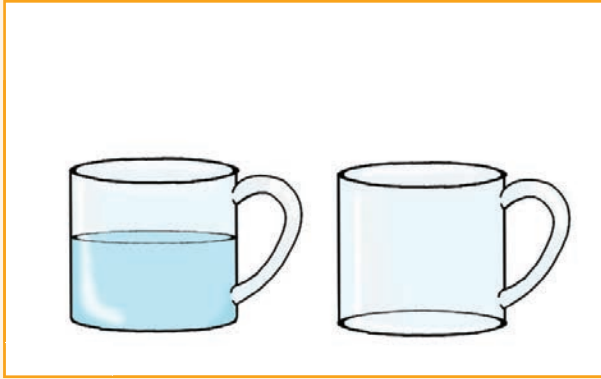

Tick which container holds more.

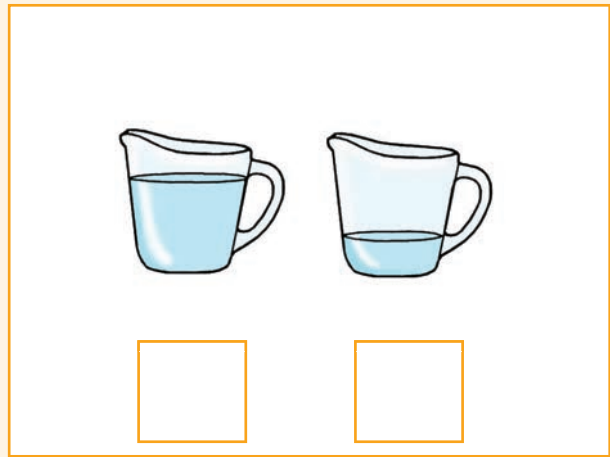
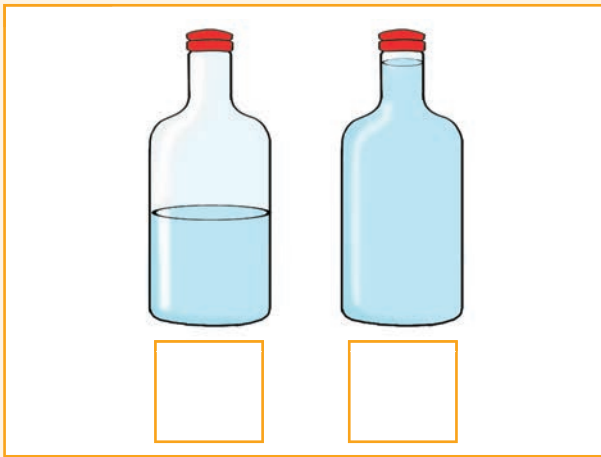

Tick which container holds less.

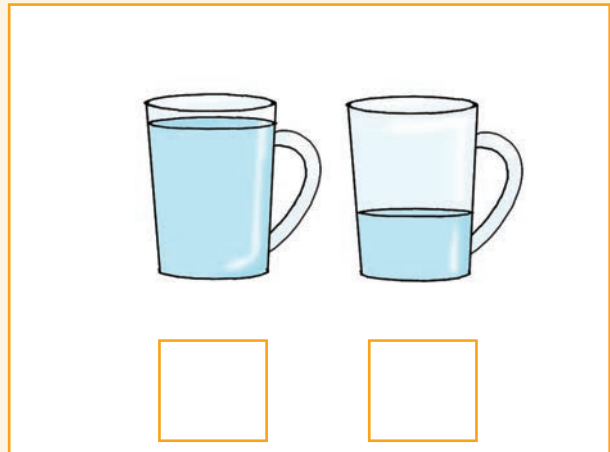
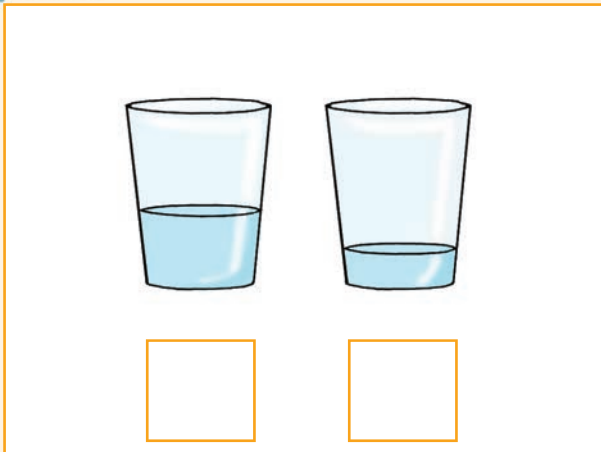



Colour in the second glass so that it has less juice than the first glass.

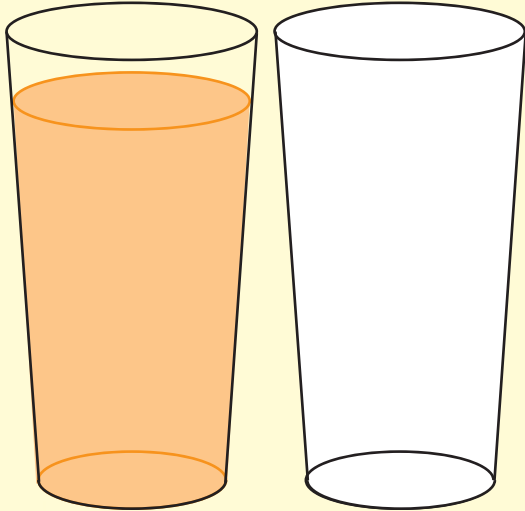

Colour in the second glass so that it has more juice than the first glass.

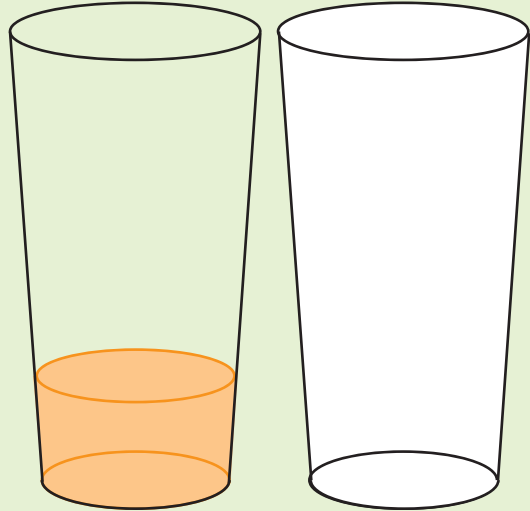

Circle more than, less than or the same as.

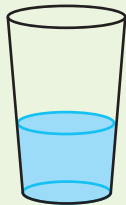

The blue glass has

more than

less than

the same as

the red glass.

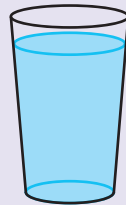
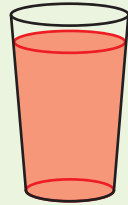

The blue glass has

more than

less than

the same as

the red glass.

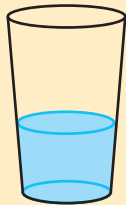
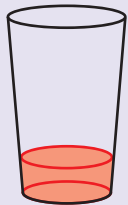

The blue glass has

more than

less than

the same as

the red glass.



more than

less than



Teacher:
Sign:

Date:

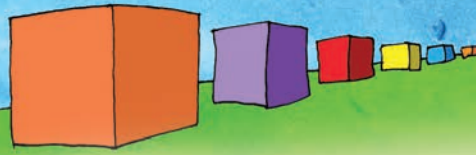

Number 1 to 10



In each block, circle the group with the fewest shapes.

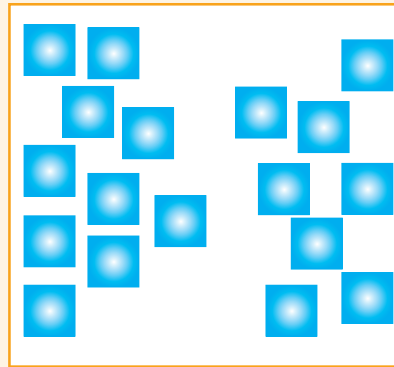
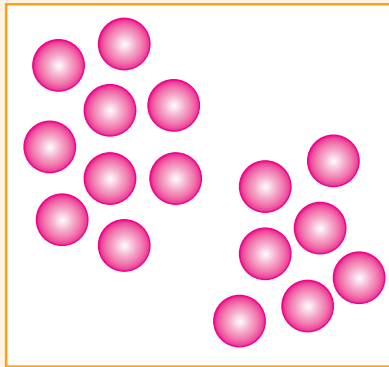
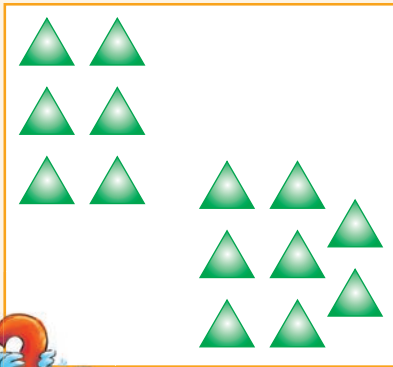

Write the numbers from the smallest to the biggest on the number line.

2 4 3
6 1 5

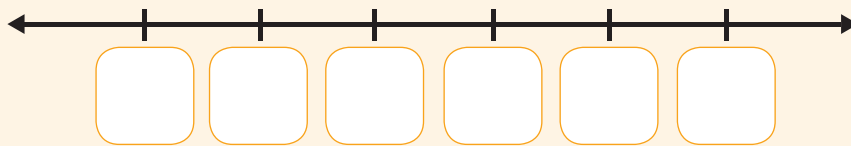

4 6 8
7 9 5

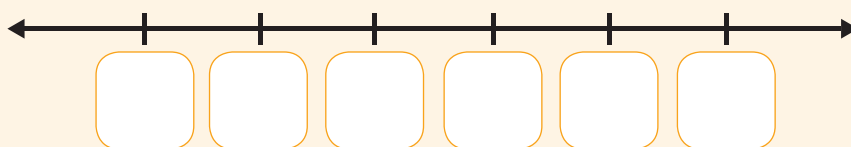

Colour the smallest number green and the biggest number orange.

7 4 3

9 10 8

5 1 6

4 6 2



Solve the following. You can make drawings to help you.

One more than 5.

One less than 5.

Two more than 6.

Two less than 7.

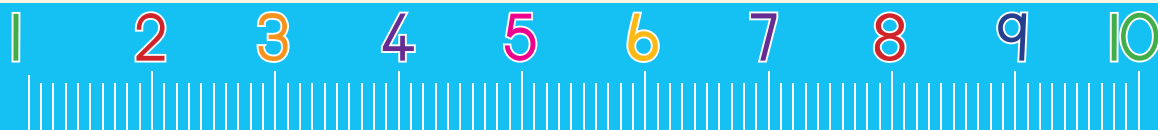



Bead line



Fill in the missing numbers.

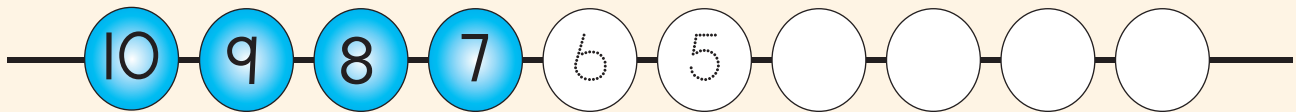
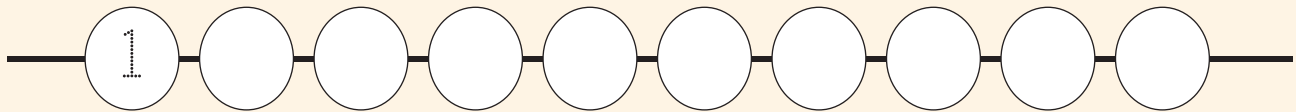
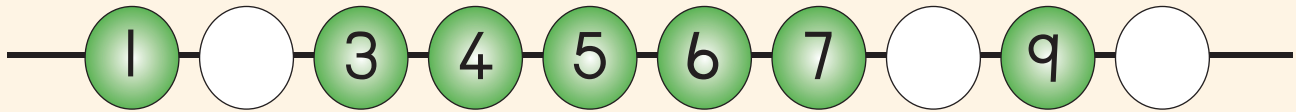
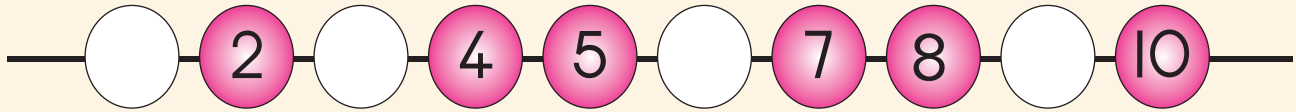
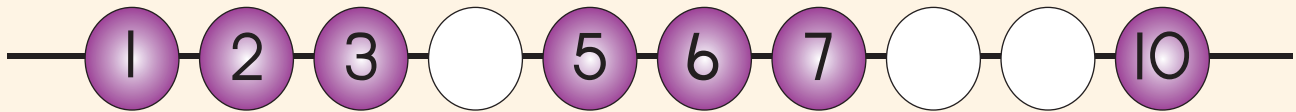
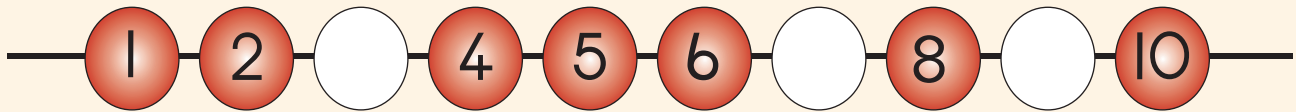
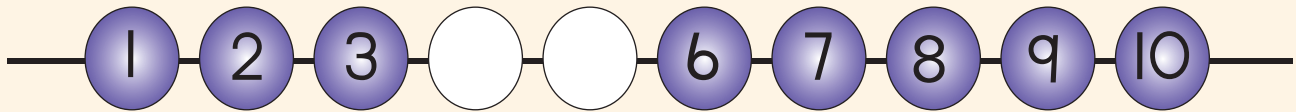
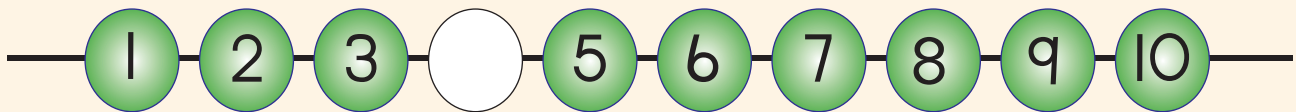
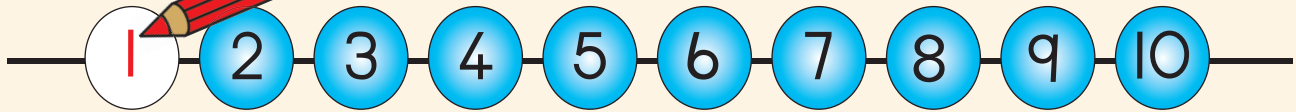

Teacher: _____
Sign: _____
Date: _____





More, equal and less

Match the objects on the left with the objects on the right.
Colour the correct answer.



same

not the same

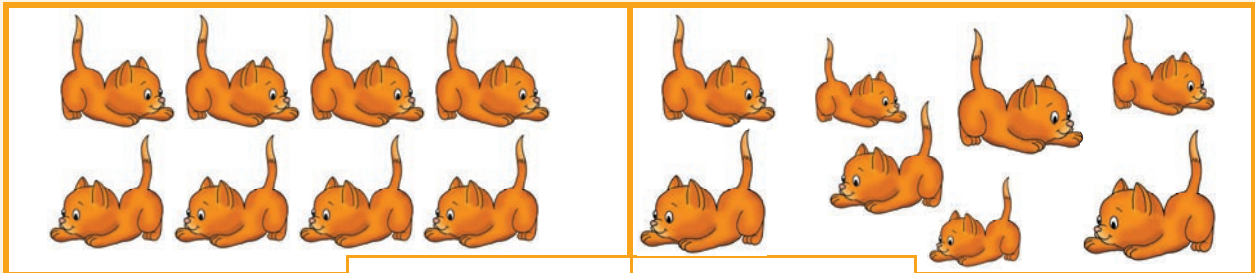

same

not the same



same

not the same

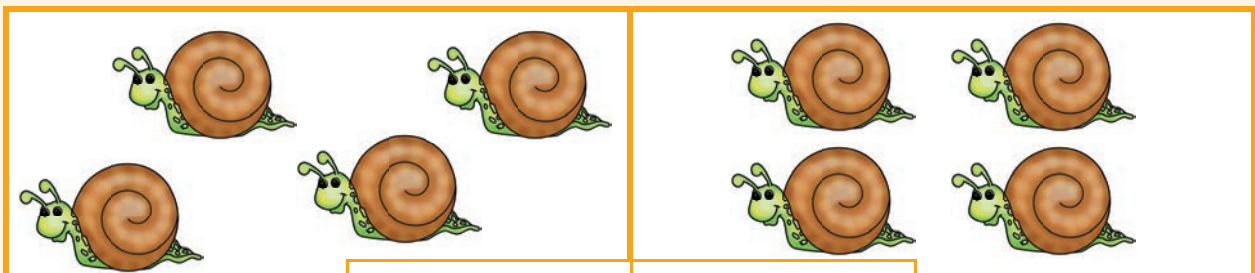

same

not the same





Say if the second block is more than, less than, or equal to, the first block.
Colour the correct answer.

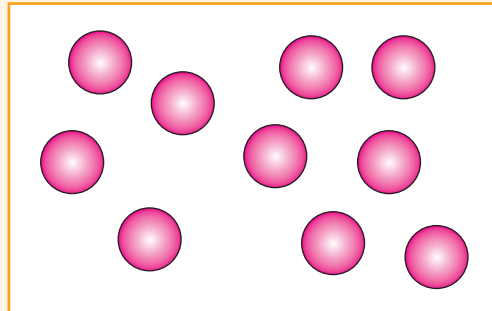
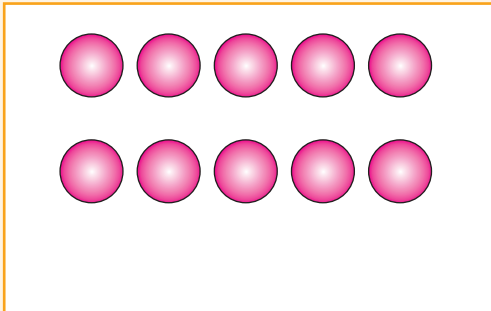

- more
- equal
- less

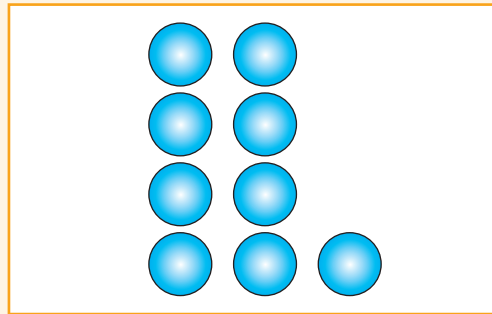
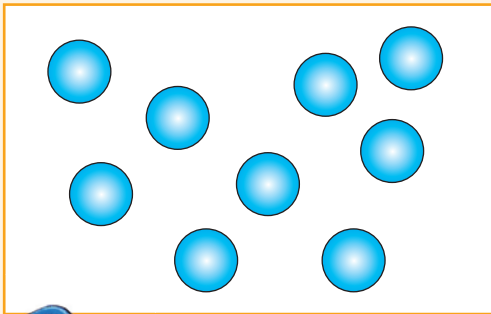

- more
- equal
- less



Match the objects with the numbers.

- 1
- 2
- 3
- 4
- 5
- 6
- 7
- 8
- 9
- 10

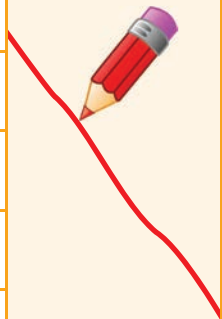

6
2
4
8
1
7
3
5
9
10



Teacher: _____
Sign: _____
Date: _____



Adding

Add these sweets and then fill in the answers.

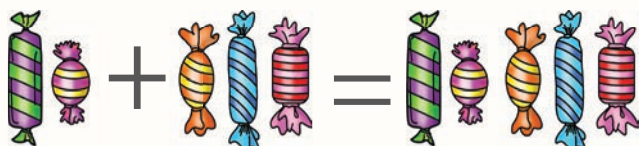

$$2 + 3 = 5$$

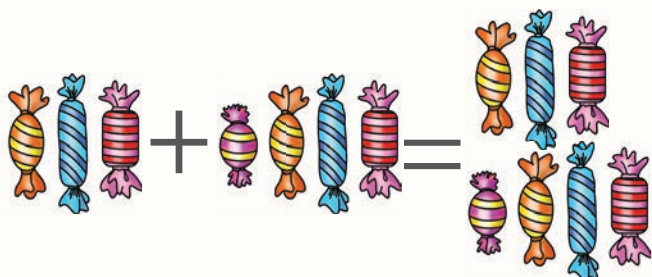

$$3 + 2 =$$



Add the numbers.

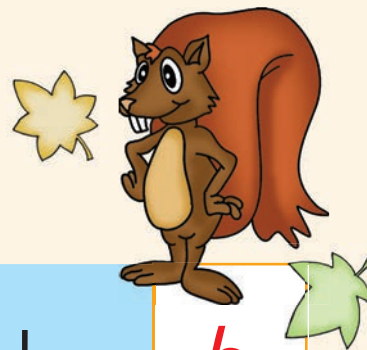

$$5 + 1 = 6$$



$$5 + 0 =$$



$$3 + 2 =$$



$$4 + 3 =$$





Try these.

$3 + 6 = 9$

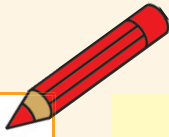

$1 + 1 = \square$

$4 + 0 = 4$

$0 + 7 = \square$

$0 + 5 = 5$

$3 + 2 = \square$

$6 + 0 = \square$

$5 + 3 = \square$

$2 + 2 = \square$

$7 + 2 = \square$

$1 + 3 = \square$

$4 + 4 = \square$

$2 + 5 = \square$

$5 + 1 = \square$

$5 + 0 = \square$

$4 + 3 = \square$

$1 + 8 = \square$

$2 + 6 = \square$

$4 + 2 = \square$

$8 + 2 = \square$



Teacher: _____
Sign: _____
Date: _____



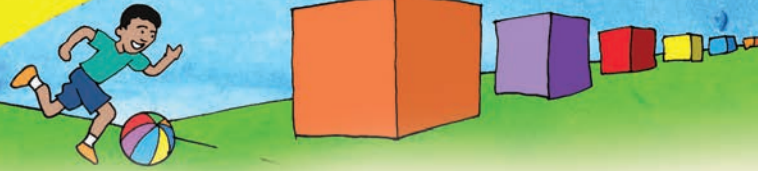

Collecting and organising

Sort and make a drawing of your sorted collections.

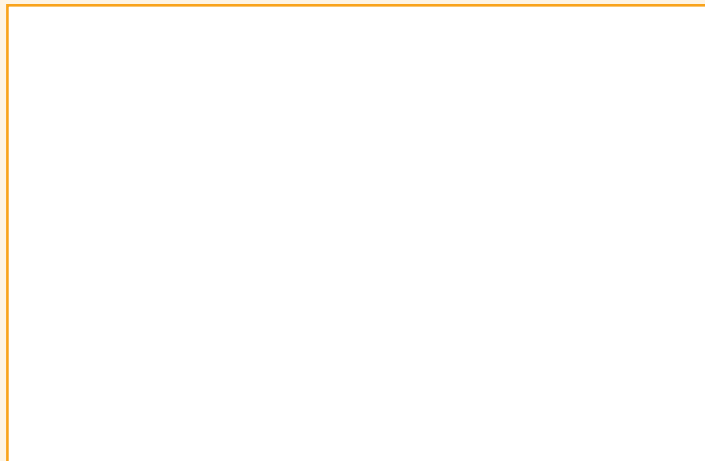
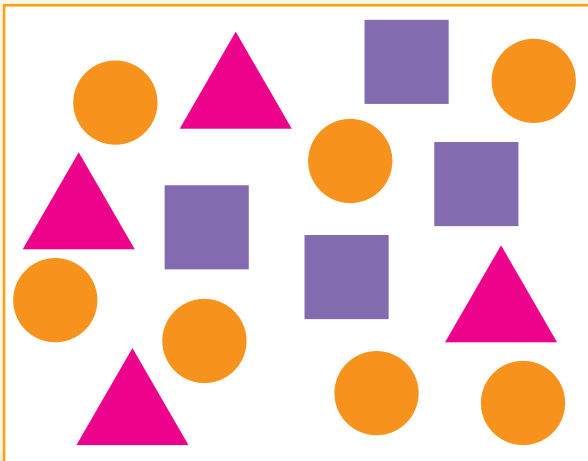
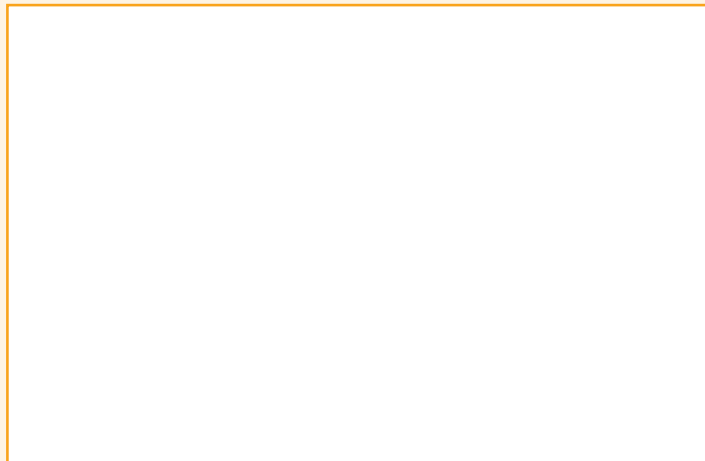
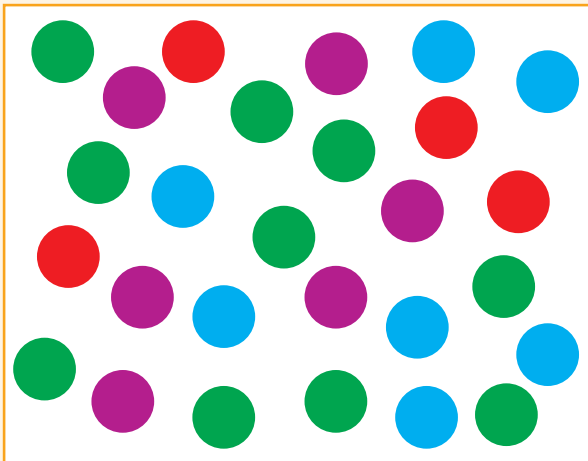
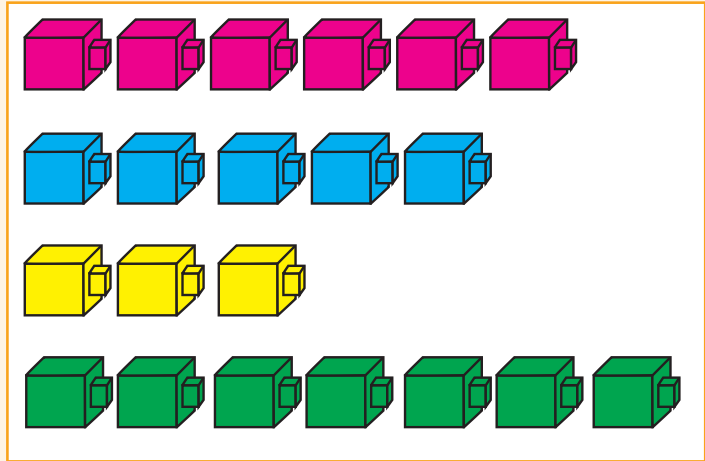
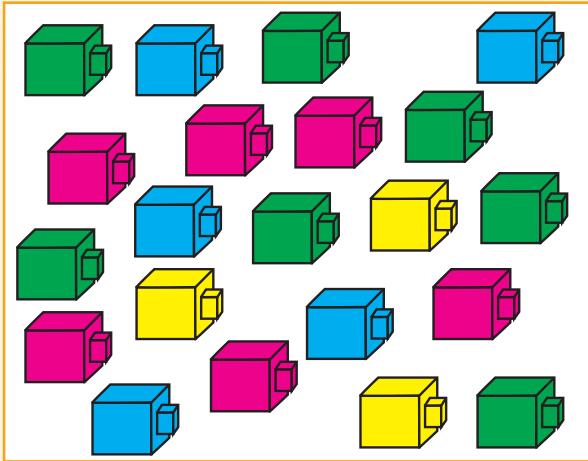



Sort the following leaves by making a drawing.

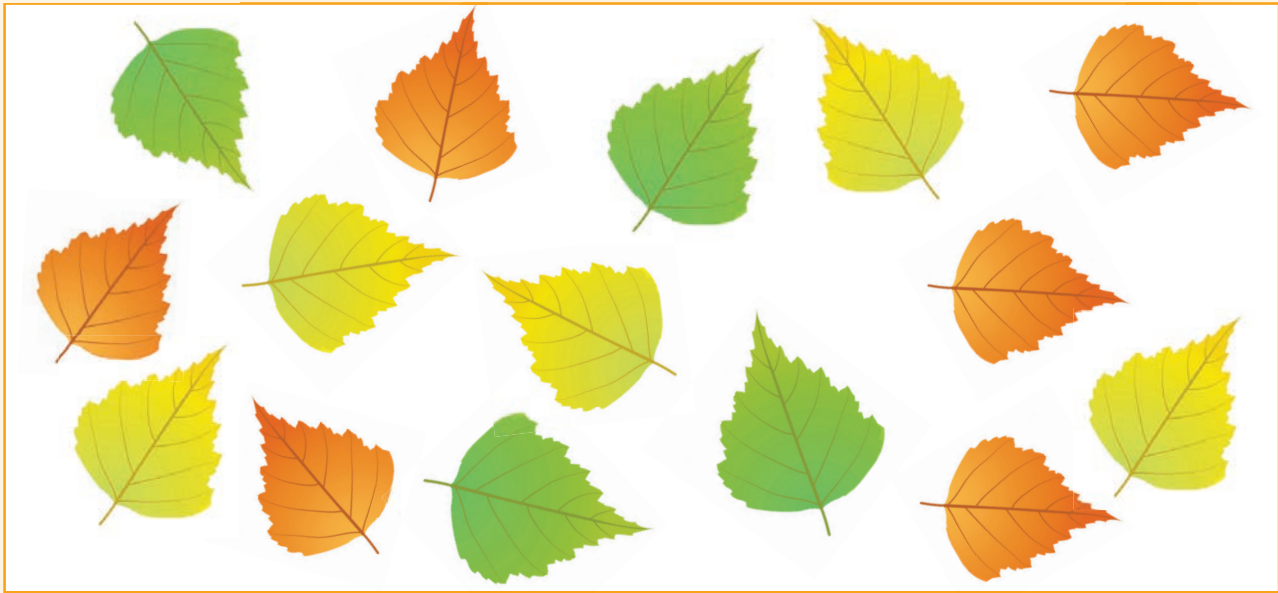

How many **yellow** leaves are there?

How many **orange** leaves are there?

How many **green** leaves are there?



Teacher: _____
Sign: _____
Date: _____



Addition to 10: counting on

Draw a picture and write a number sentence for each.

Sarah has 3 sweets. Sipho has 2 sweets. How many sweets do they have altogether?



Let us count:

3

4

5

$$\square + \square = \square$$

I have 4 marbles and won 3 more marbles. How many marbles do I have?

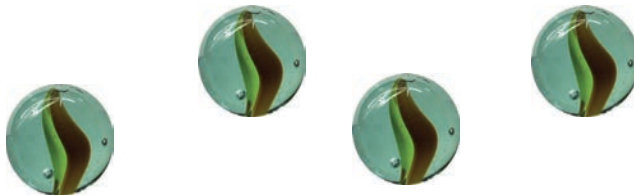

Let us count:

4

5

6

7

$$\square + \square = \square$$

There were 5 butterflies. Two more joined them. How many butterflies are there?



Let us count:

5

6

7

$$\square - \square = \square$$





Fill in the numbers on the number line and then write a number sentence for each.

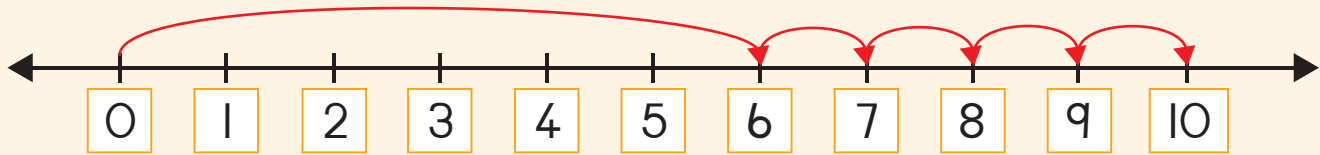

$$6 + 4 = \square$$

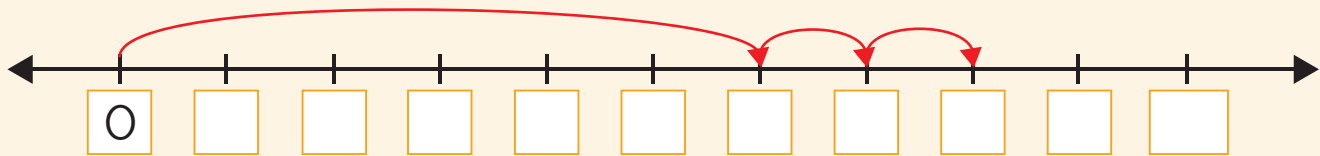

$$\square + \square = \square$$

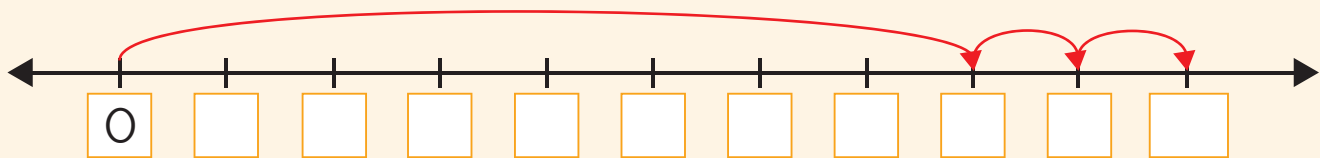

$$\square + \square = \square$$

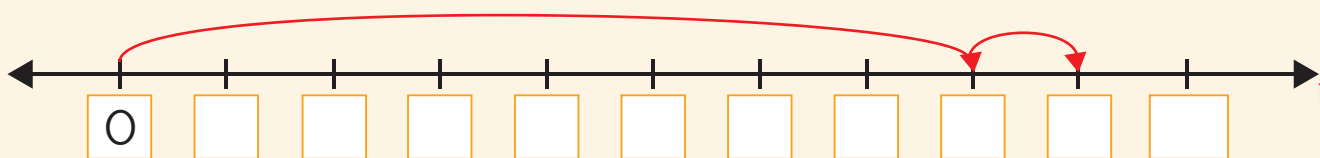

$$\square + \square = \square$$



Teacher: _____
Sign: _____
Date: _____





Addition: building and breaking to 10

Colour to show the following.

$1 + 9$	
$2 + 8$	
$3 + 7$	
$4 + 6$	
$5 + 5$	



Write a sum for:

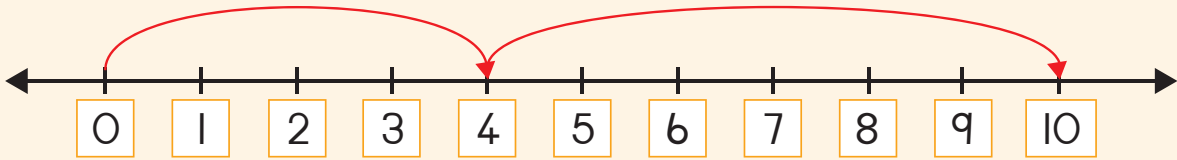

$$4 + 6 = \square$$

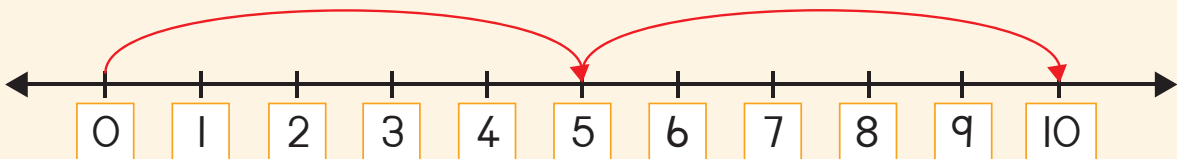

$$\square + \square = \square$$

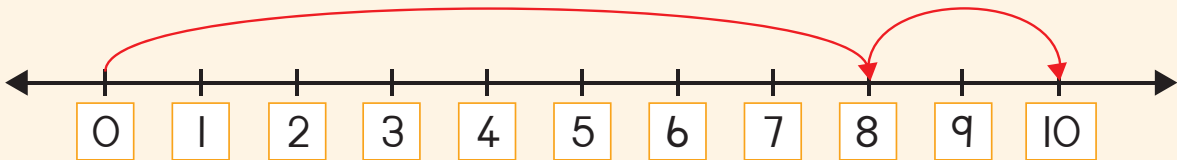

$$\square + \square = \square$$





Use the numbers of flowers to make your own number sentence.



$$\square + \square + \square = \square$$



$$\square + \square + \square = \square$$



$$\square + \square + \square = \square$$



$$\square + \square + \square = \square$$



Write a sum for:

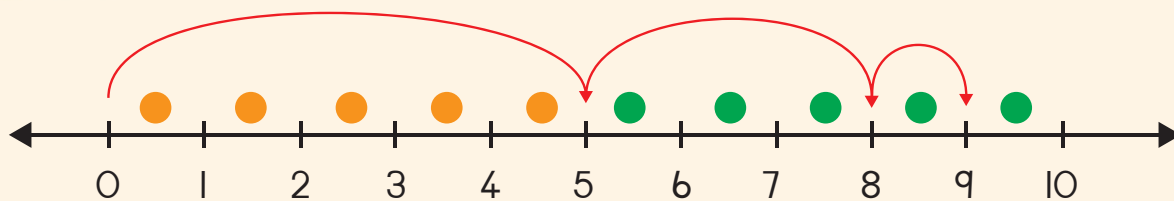

$$\square + \square + \square = \square$$

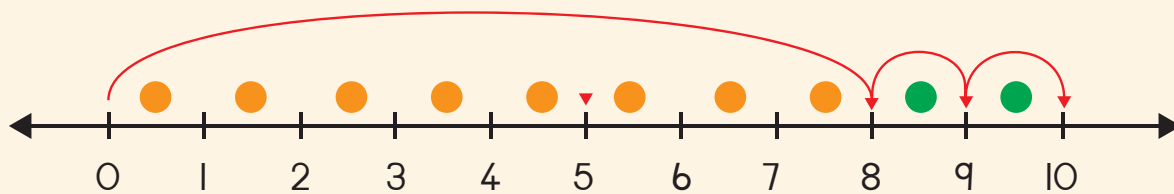

$$\square + \square + \square = \square$$



Teacher: _____
Sign: _____
Date: _____





Answer the following.

Doubling and halving

How many girls do you see?



How many girls do you see now?



Double 1 is 2.

What if we halve the number of girls?

How many feet do you see?



How many feet do you see now?



We say double 2 is 4.

What will halve of 4 be?

How many wheels do you see?



How many wheels do you see now?



We say double 3 is 6.

What will halve of 6 be?

How many legs do you see?



How many legs do you see now?



We say double 4 is 8.

What will halve of 8 be?



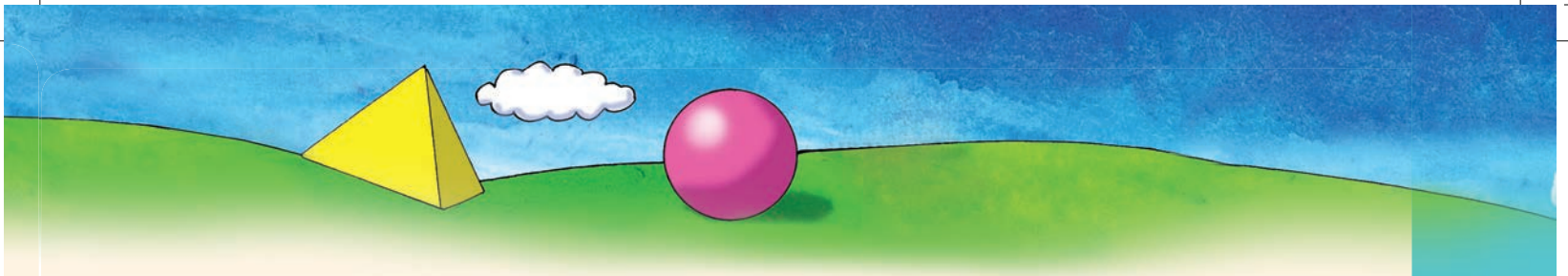

How many fingers do you see?



How many fingers do you see now?

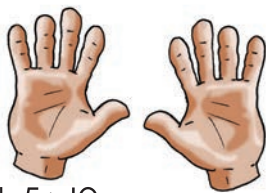

We say double 5 is 10.
What will halve of 10 be?



Solve the following by colouring. Write the sum.

I have 4 marbles and my friend has 4. How many marbles do we have altogether?
Colour the correct number of marbles.

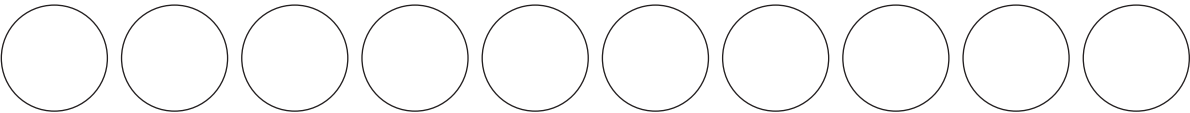

+ =



Answer the following.

Double 1 is

Double 2 is

Double 3 is

Double 4 is

Double 5 is

Half 2 is

Half 4 is

Half 6 is

Half 8 is

Half 10 is



Teacher:
Sign:
Date:





Complete the shapes.

square

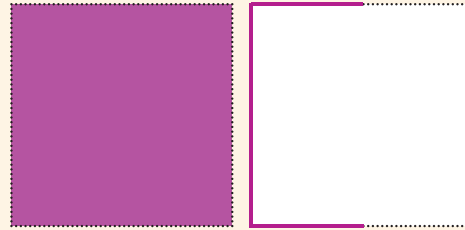

circle

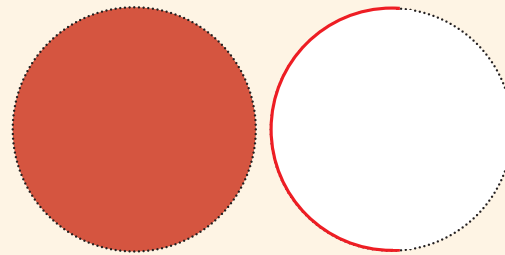

triangle

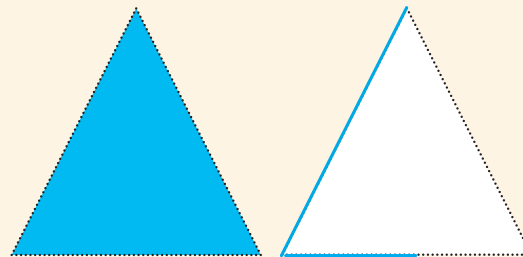

rectangle



Use the four shapes above to draw a picture. You can use the shapes more than once.

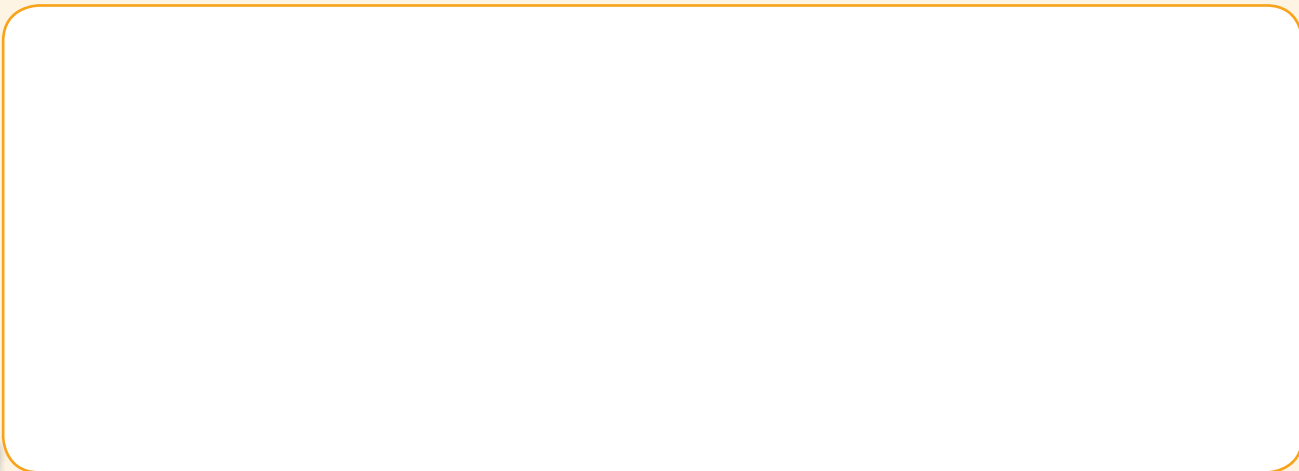

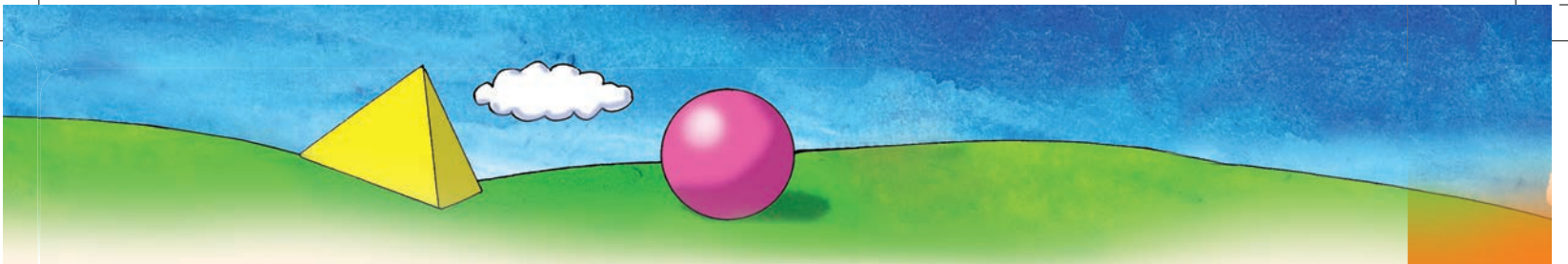

Use your cut-out shapes to form these pictures.

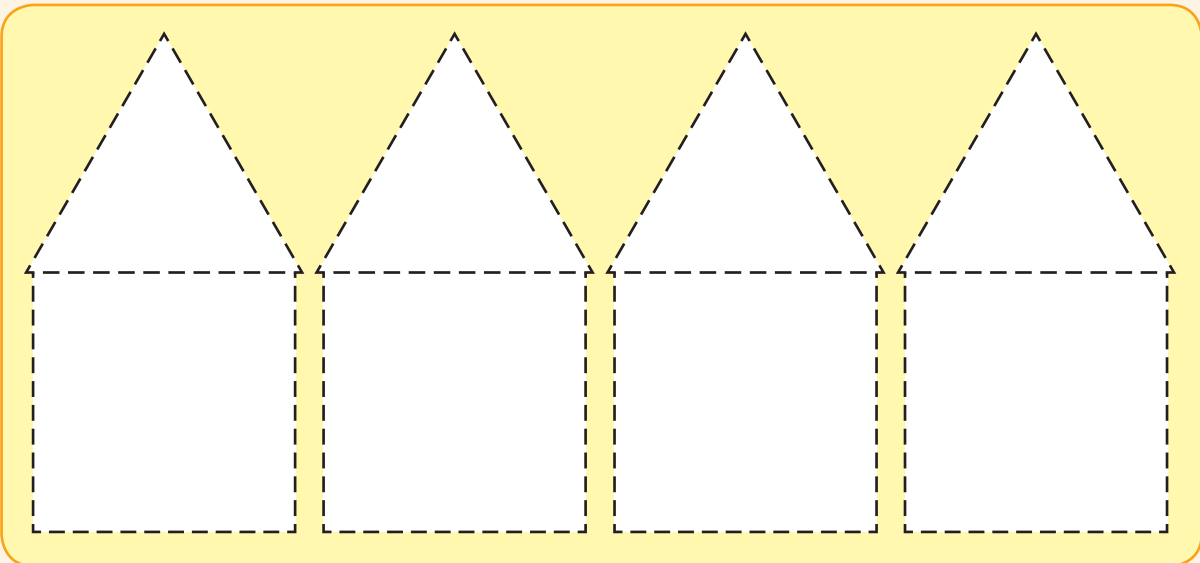
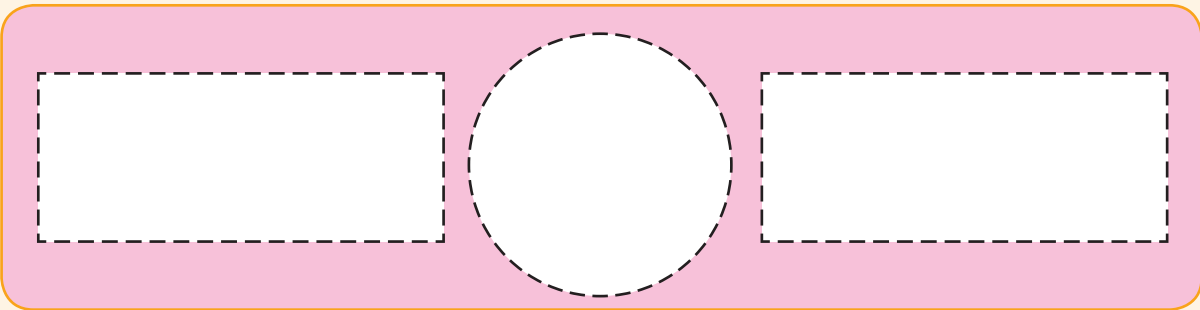
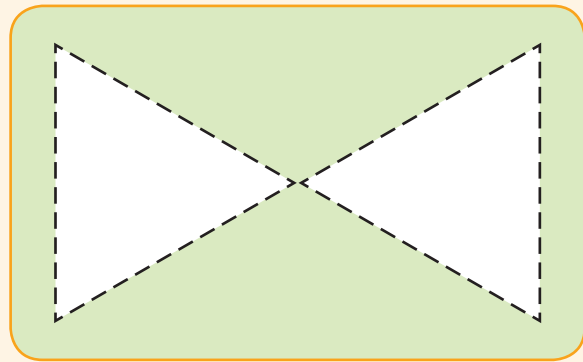
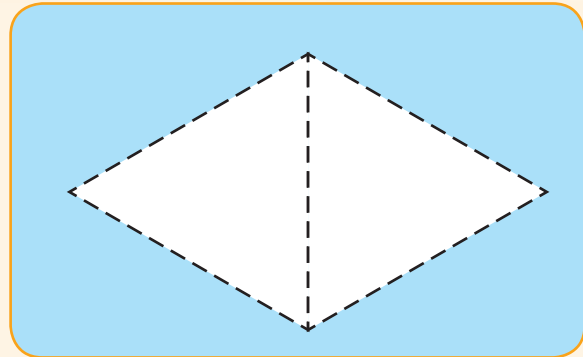
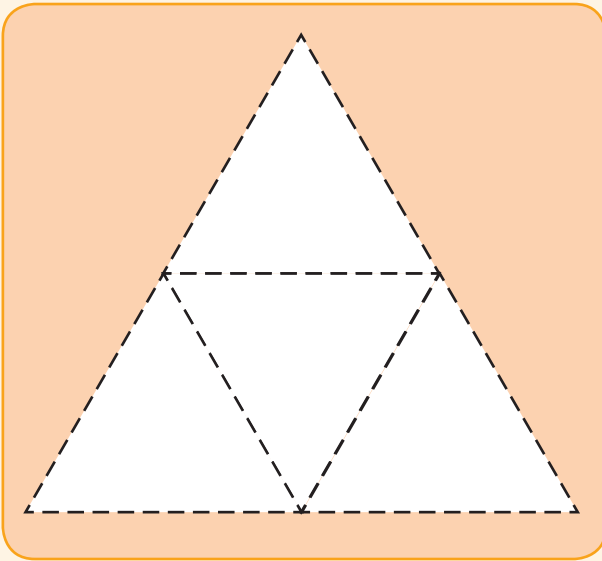

Teacher:
Sign:
Date:



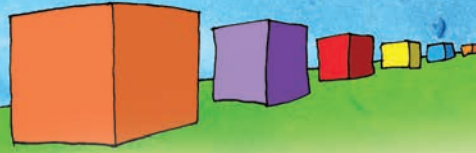

More 2-D shapes



Sort the shapes and make a drawing of your sorting.

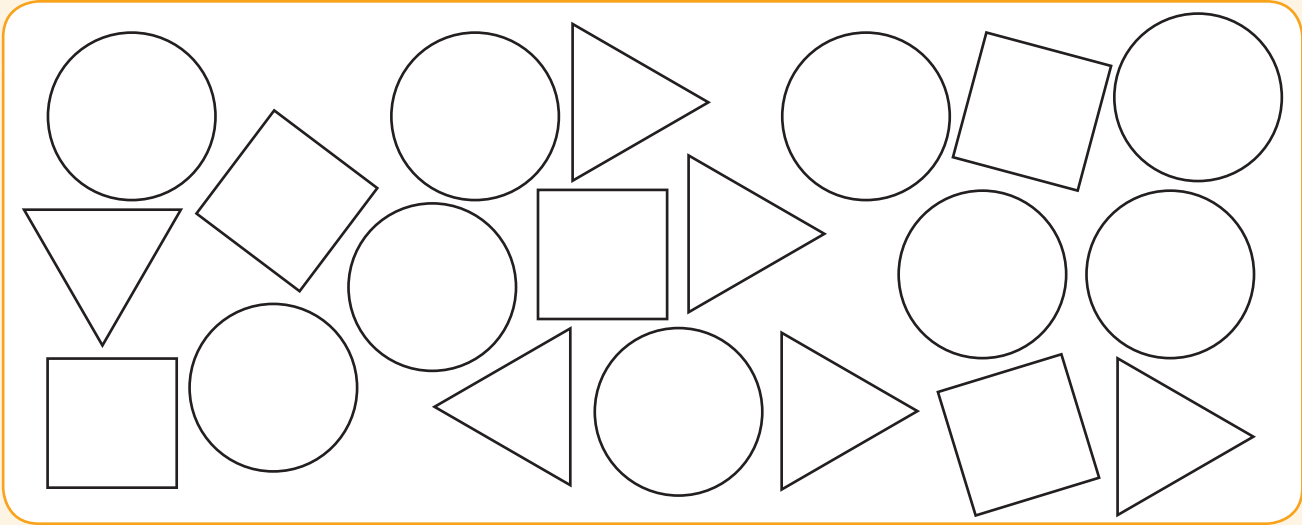

Triangle

Circle

Square

How many triangles are there?

How many circles are there?

How many squares are there?









Find the shapes

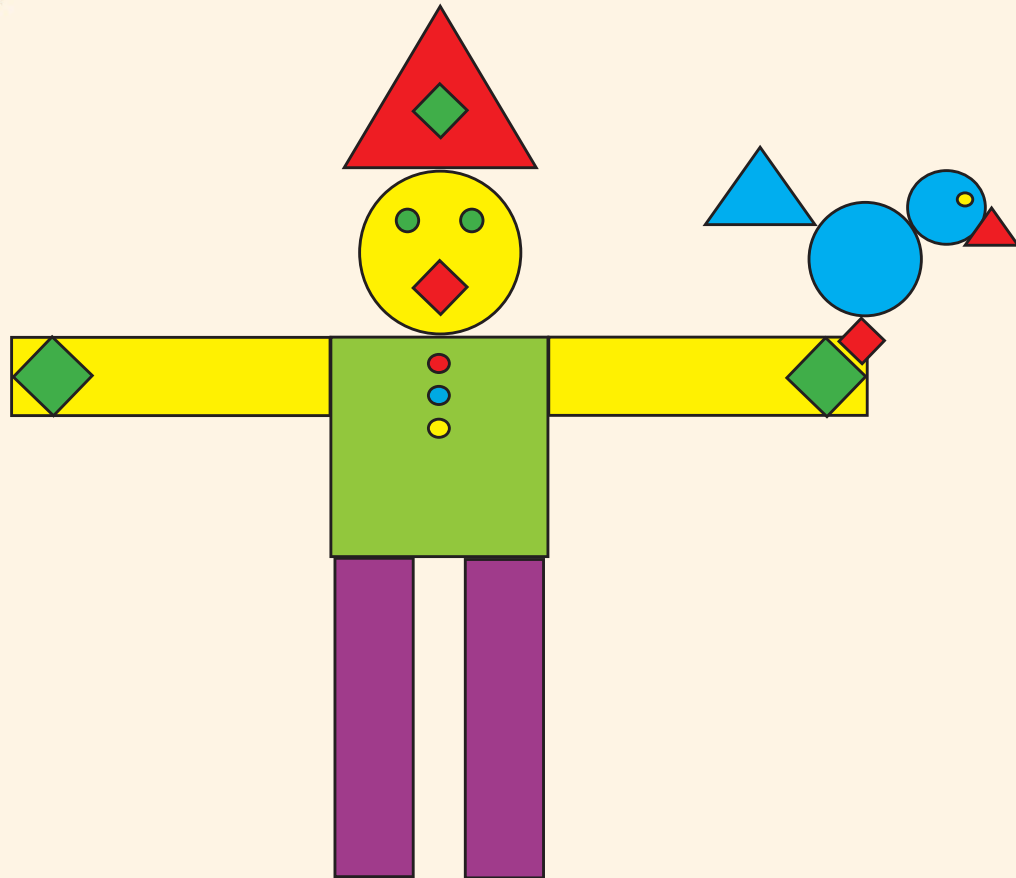

Find the different shapes and then count them.



	How many squares can you find?	
	How many circles can you find?	
	How many triangles can you find?	
	How many rectangles can you find?	



Teacher:
Sign:
Date:



Answer the questions:

Groups of two to 10

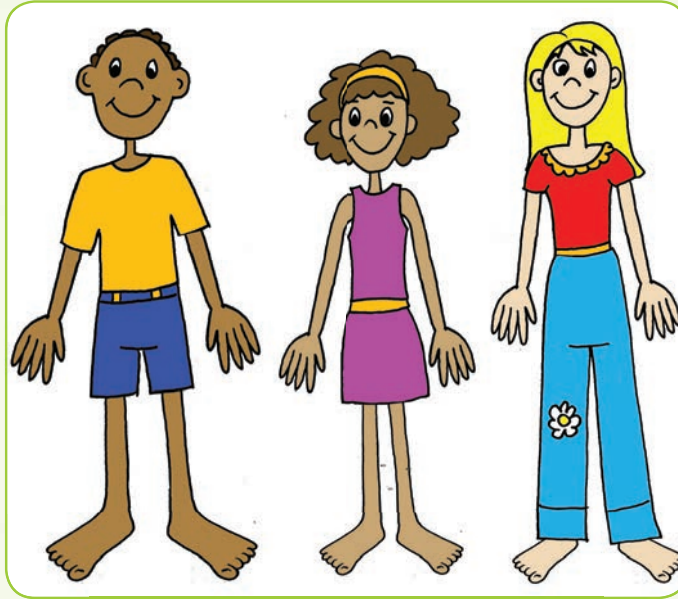

How many children do you see?

How many pairs of feet do you see?

Write a sum for the pairs of feet.

$$2 + 2 + 2 =$$



Draw circles around the following to make:

2 groups of 2



4 groups of 2

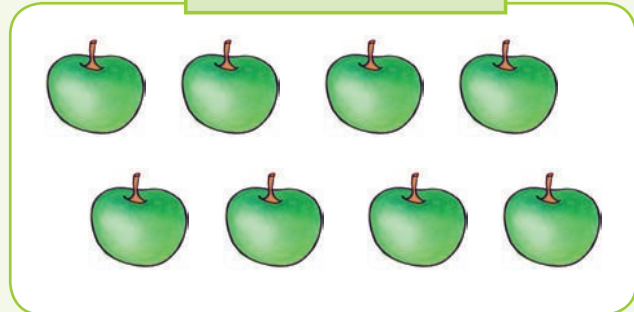



5 groups of 2



3 groups of 2



Write a sum for the following:

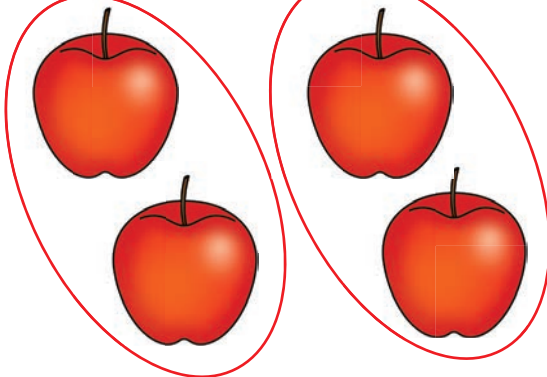

$2 + 2 =$

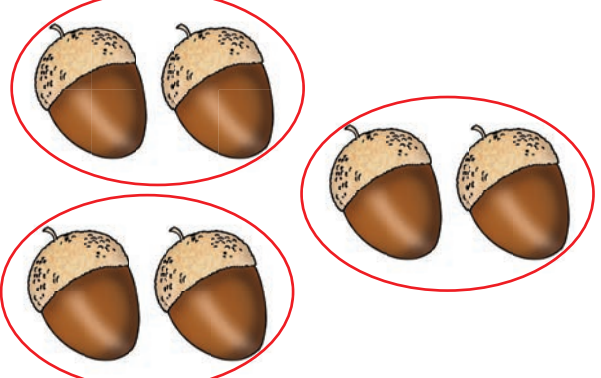
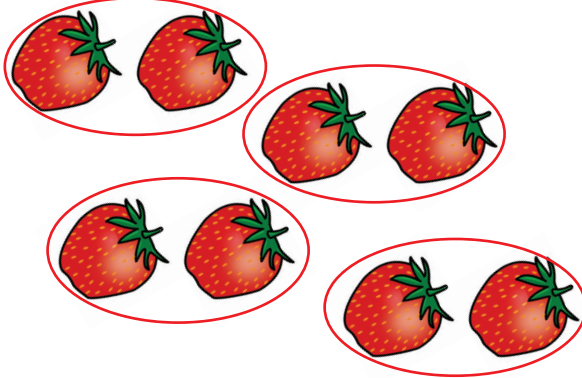
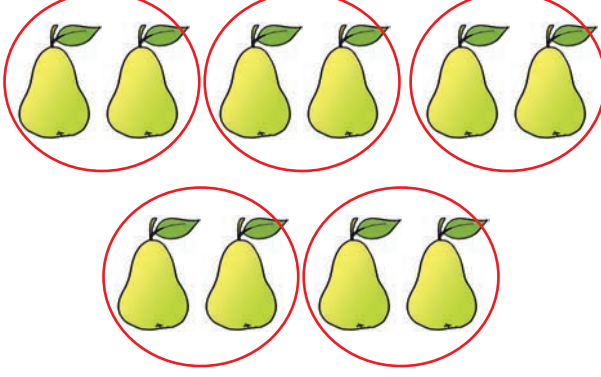

Teacher:
Sign:

Date:





Repeated addition of twos up to 10

How many legs are there? Write a sum for it.



$$2 + 2 + 2 = 6$$



Calculate and then make a drawing.

$$2 + 2 = 4$$



$$2 + 2 + 2 = \square$$

$$2 + 2 + 2 + 2 = \square$$

$$2 + 2 + 2 + 2 + 2 = \square$$



Write a sum for:

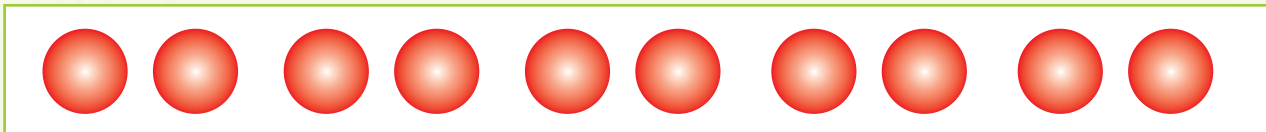

$$2 + 2 + 2 + 2 + 2 =$$

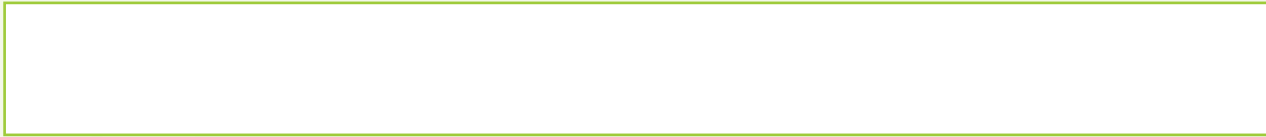
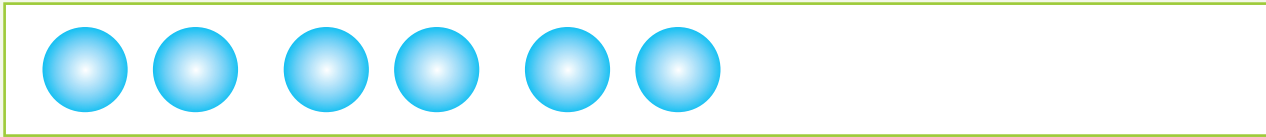
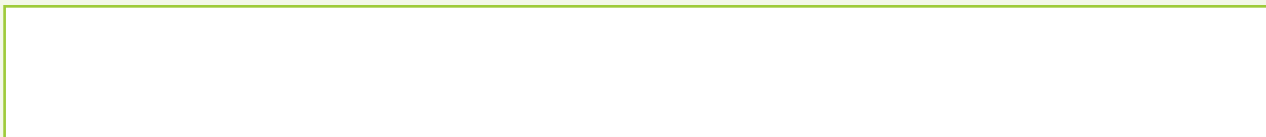
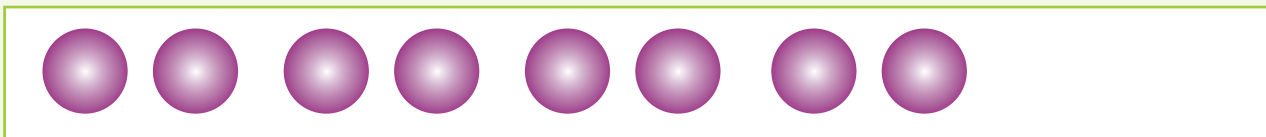
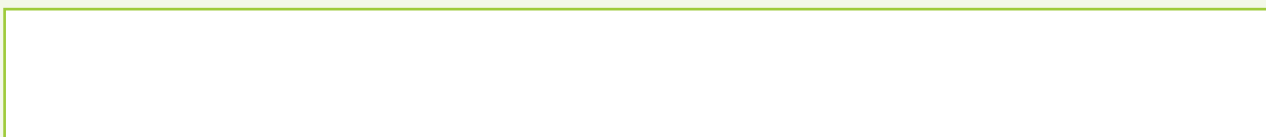
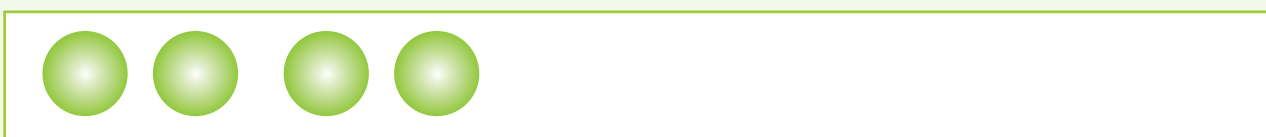

Count these numbers in twos and then colour the ones you counted.

1	2	3	4	5	6	7	8	9	10
---	---	---	---	---	---	---	---	---	----



Teacher:
Sign:
Date:





Patterns: 2 to 20

Draw a line to match the missing number.
We did the first one for you. Then complete two more hops.

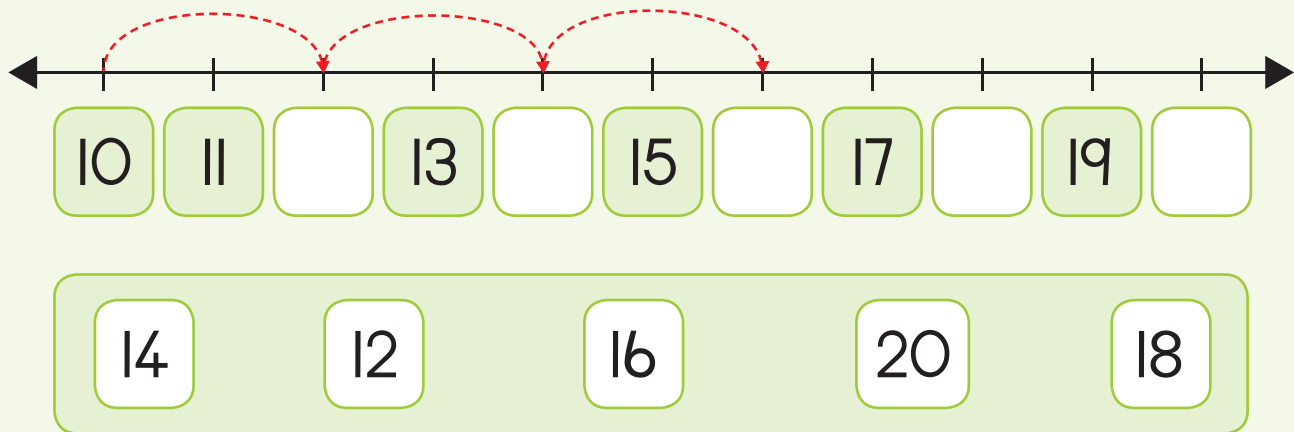
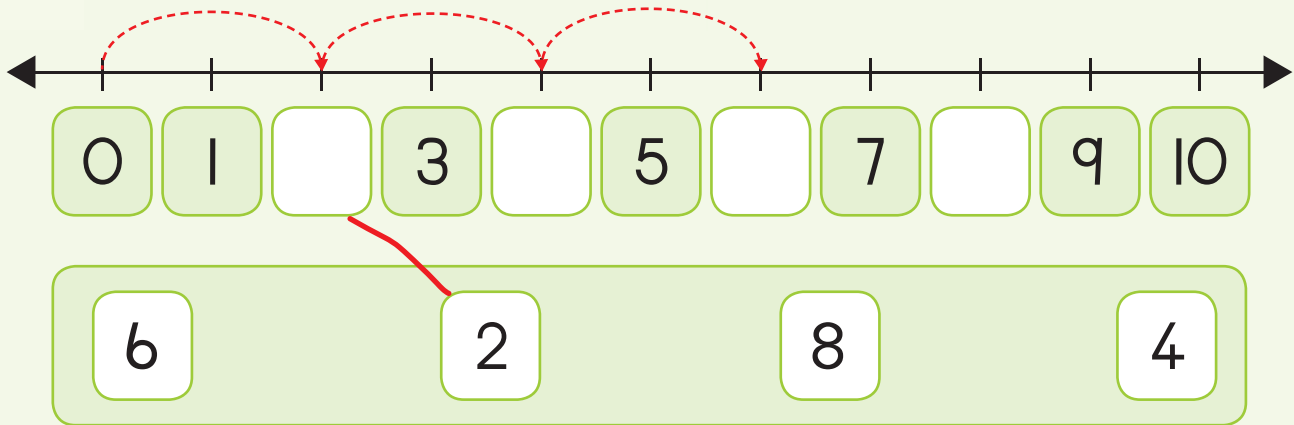

Complete the pattern by colouring the numbers.

1	2	3	4	5	6	7	8	9	10
11	12	13	14	15	16	17	18	19	20





Draw hops to show the following.

8 10 12 14

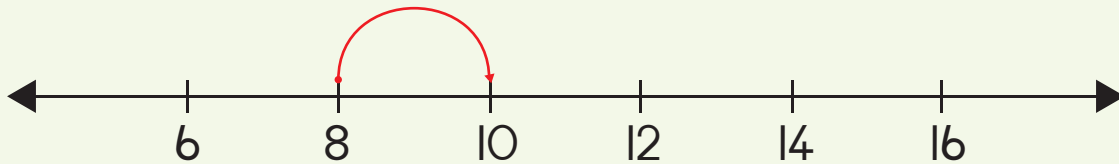

12 14 16 18

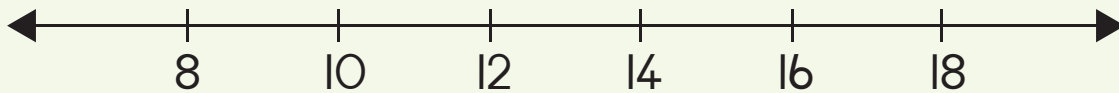

4 6 8 10



Teacher:
Sign:
Date:





Answer the questions.

Groups of three up to 10

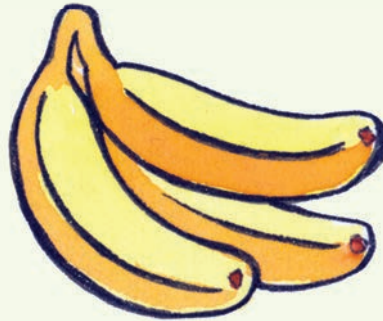
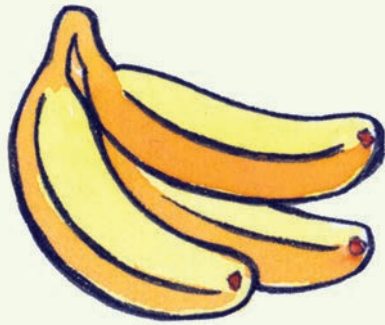

How many bananas do you count?

How many groups are there?

Write it as a number sentence.



Draw circles around the following to make:

2 groups of 3

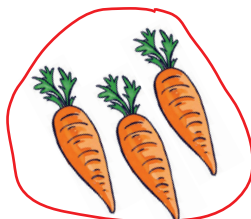

3 groups of 3





4 groups of 3



1 group of 3

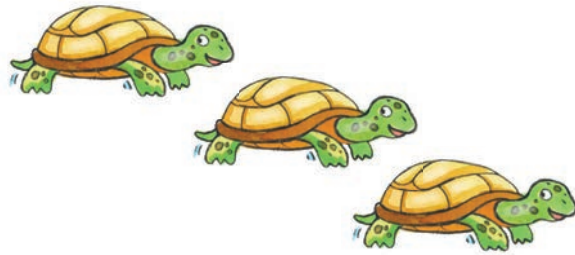

Write a number sentence for the following:

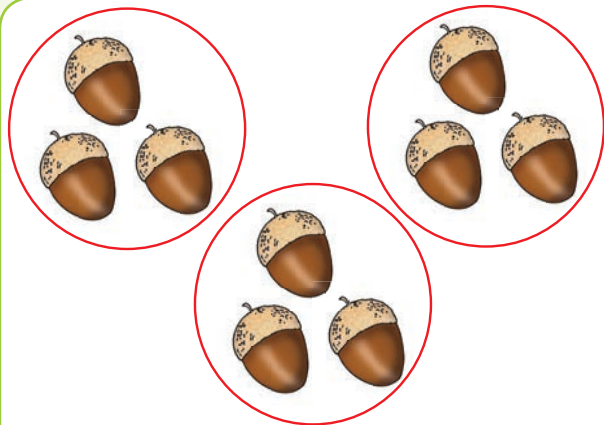
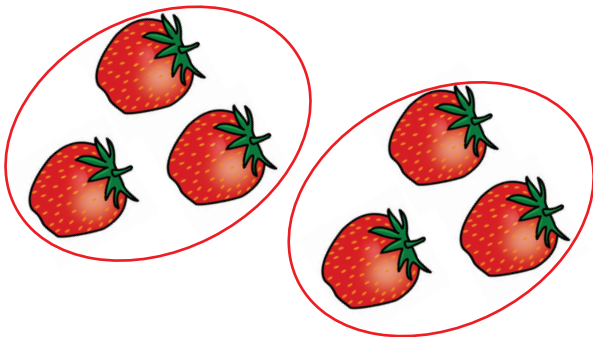

Draw 2 groups of 3.



Teacher:
Sign:
Date:





Repeated addition of threes to 10

How many wheels are there? Write it as a sum.





Draw shapes to show the following.

$$3 + 3 = \square$$

$$3 + 3 + 3 = \square$$



Write a sum for:

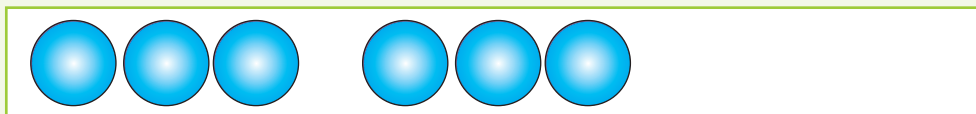
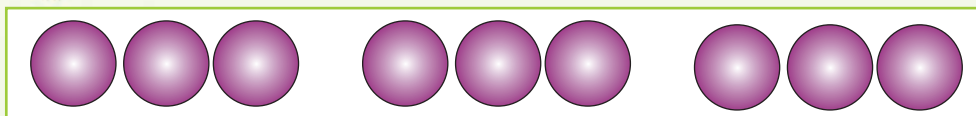

How many flowers did I buy at the market?



Sum.



Teacher:
Sign:
Date:





Groups of four up to 10

Count the shapes and write the number.

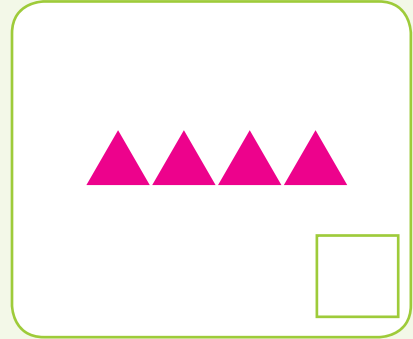
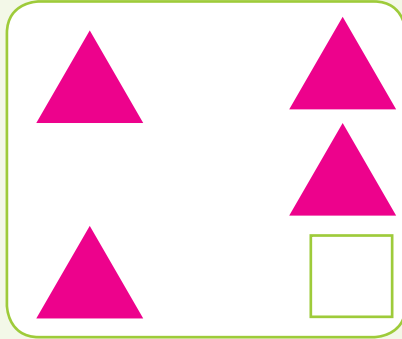
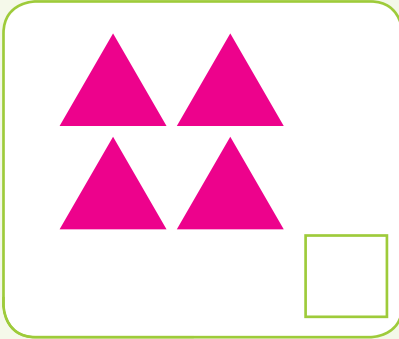

I saw the following animals in the zoo. How many legs did I see?
Write a sum for each.



$$4 + 4 = 8$$









Draw shapes around the following to make:

2 groups of 4



1 group of 4



2 groups of 4

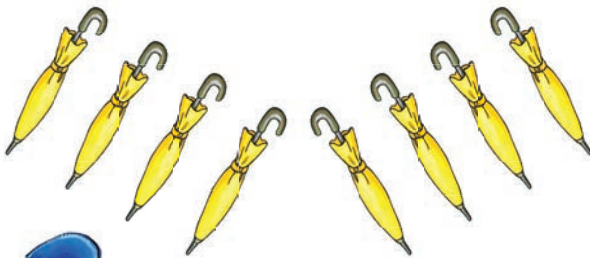

1 group of 4



Write a sum for the following:

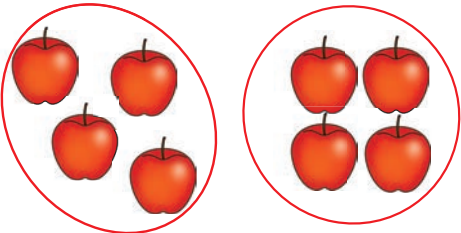

$4 + 4 =$

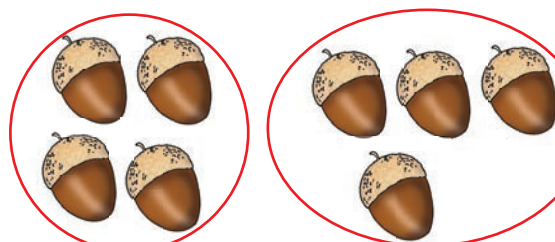
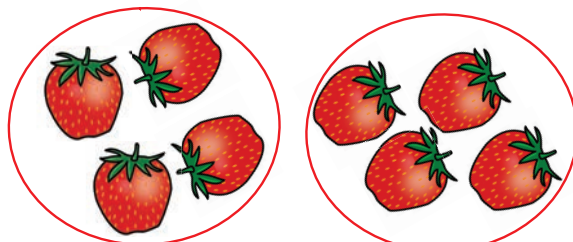
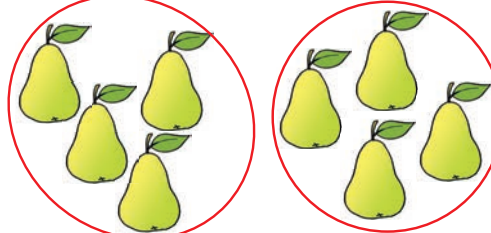

Teacher:
Sign:
Date:





Repeated addition of fours up to 10

How many legs are there? Write a sum for each.



$$\square + \square = \square$$

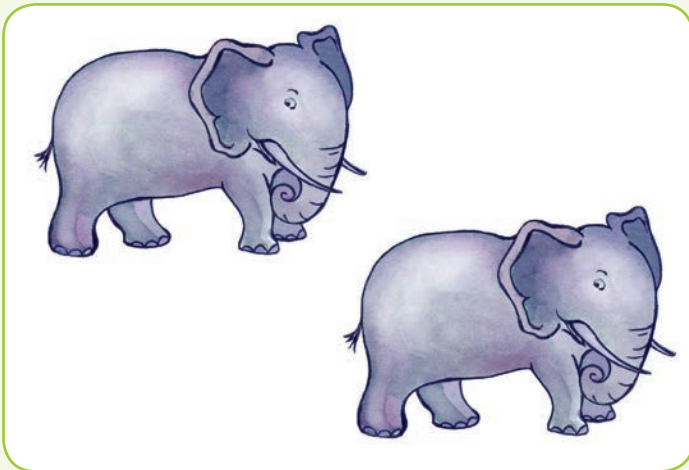

$$\square + \square = \square$$

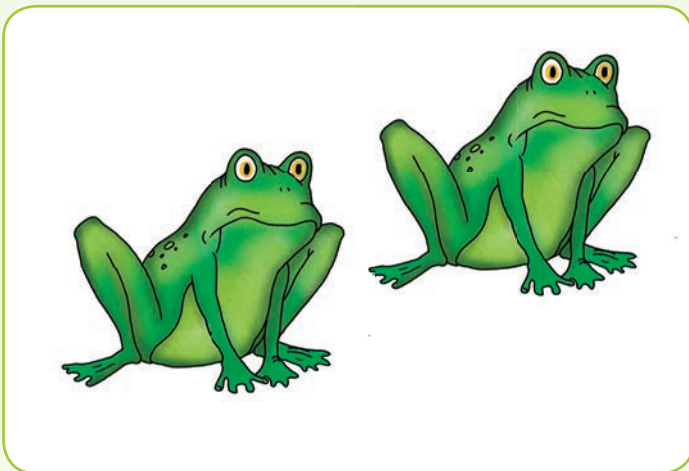

$$\square + \square = \square$$





Draw shapes to show the following.

$$\boxed{4} + \boxed{4} = \boxed{}$$

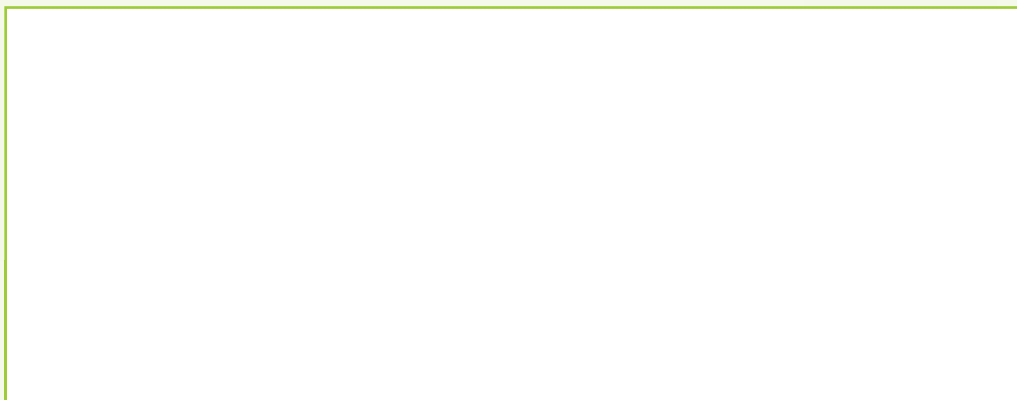

Write a sum for:

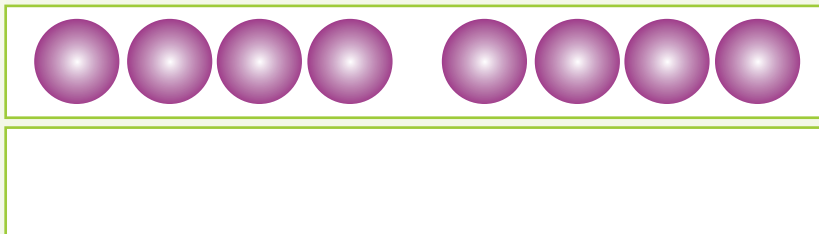

Susan baked 4 cupcakes. Jane baked 4 cupcakes.
How many cupcakes did they bake in total? Circle the correct number of cupcakes.



Sum.



Teacher:
Sign:
Date:





Answer the questions.

Groups of five up to 10

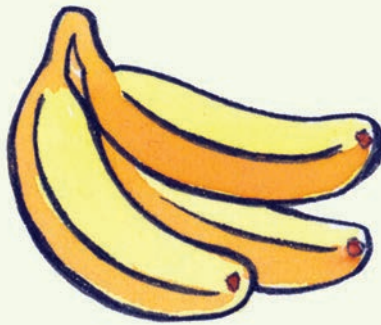

How many toes do you see on each foot?

How many toes are there altogether?

Write it as a sum.

$$5 + 5 =$$



Draw circles around the following to make:

1 groups of 5



2 groups of 5





2 groups of 5

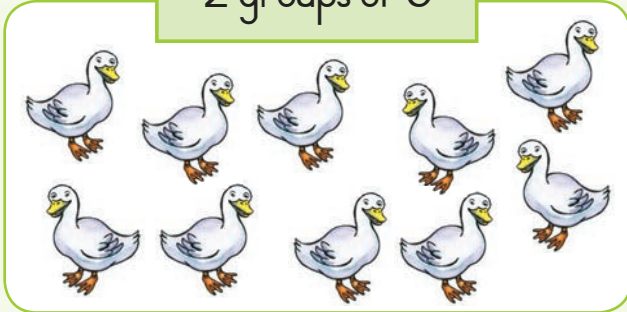

1 group of 5

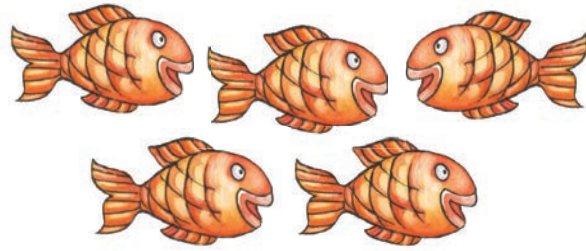

Write a sum for the following:

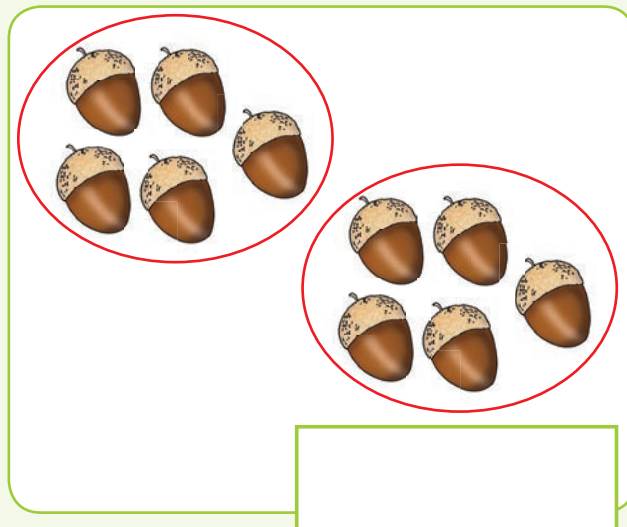
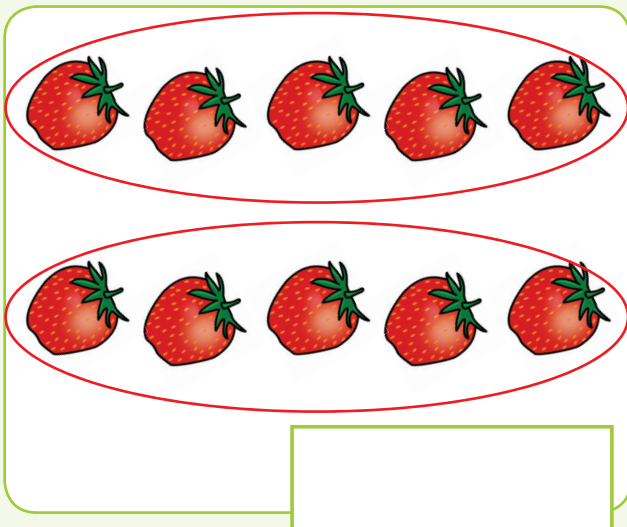
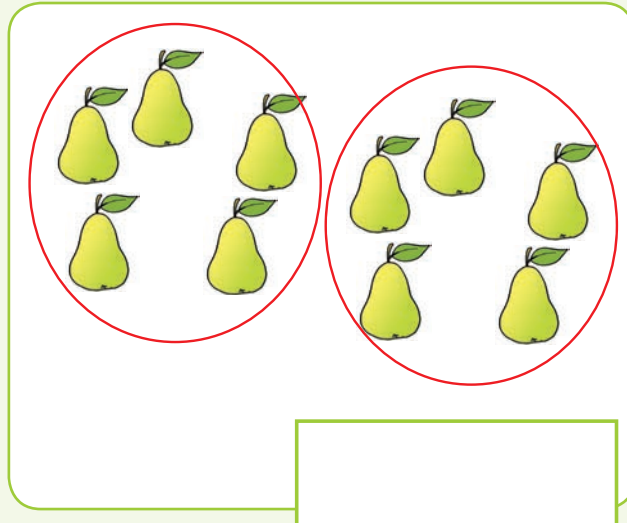
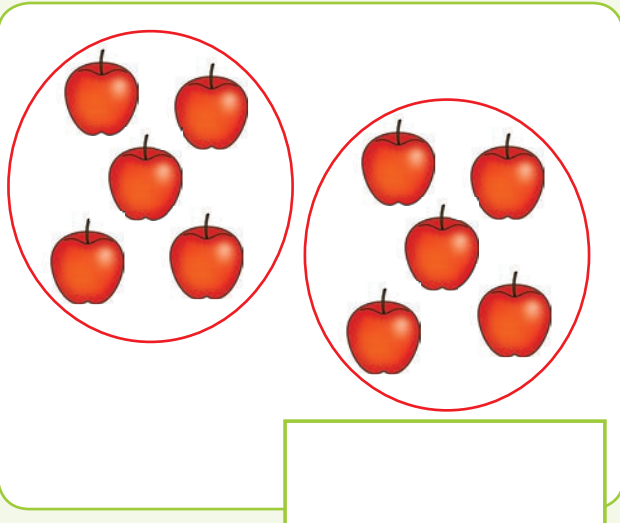

Teacher:
Sign:
Date:





Repeated addition of fives up to 10

How many fingers or toes are there?

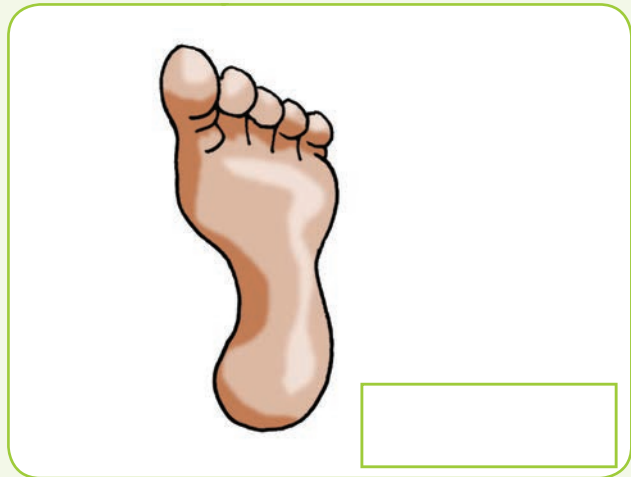
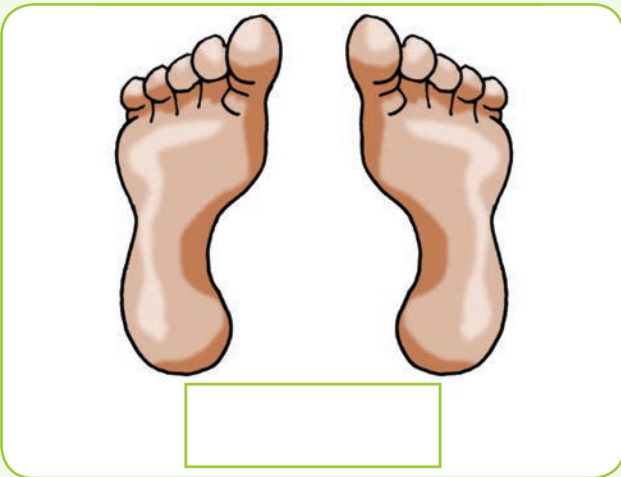
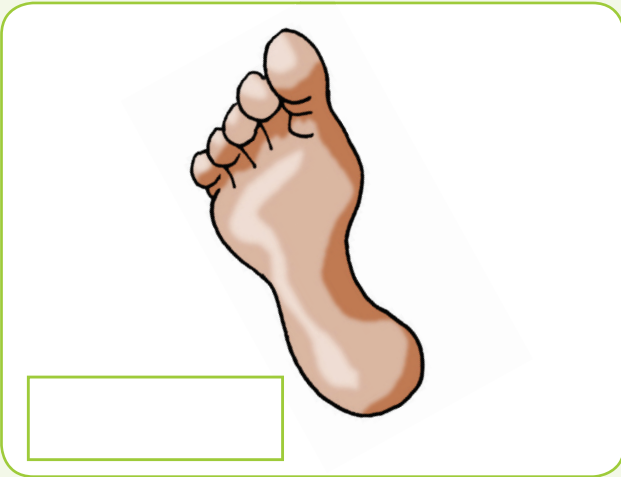
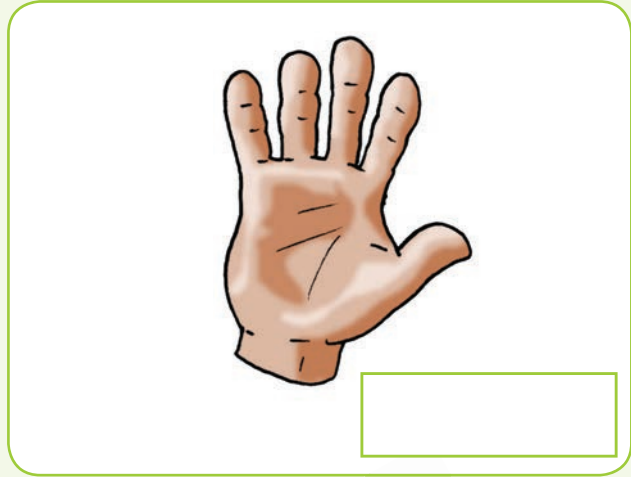
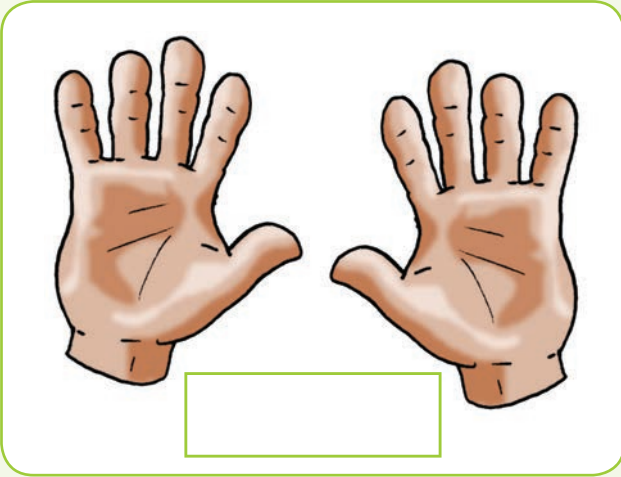



Draw shapes to show the following.

$$5 + 5 = \square$$



Write a sum for:

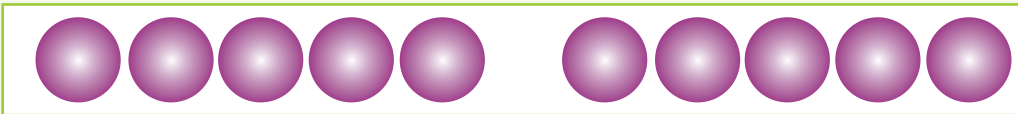

How many toes do you have on each foot? How many toes do you have in total?
Make a drawing.

Sum:



How many fingers do you have on one hand? How many fingers do you have in total?
Make a drawing.

Sum:



Teacher: _____
Sign: _____
Date: _____





Five patterns to 20

Draw a line to match the missing number. We did the first one for you.
Complete the hops by tracing over it.

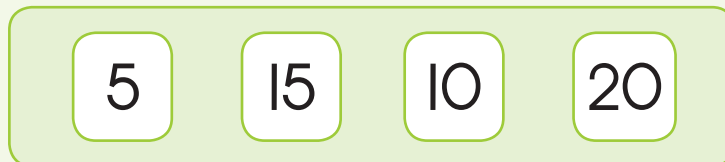
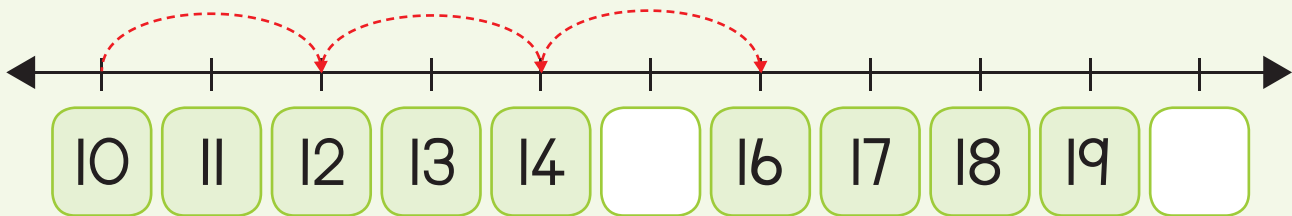
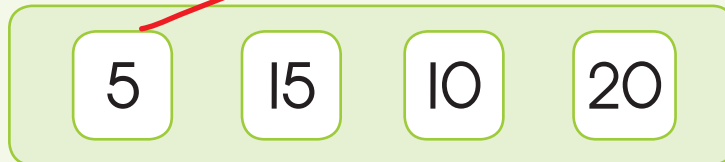
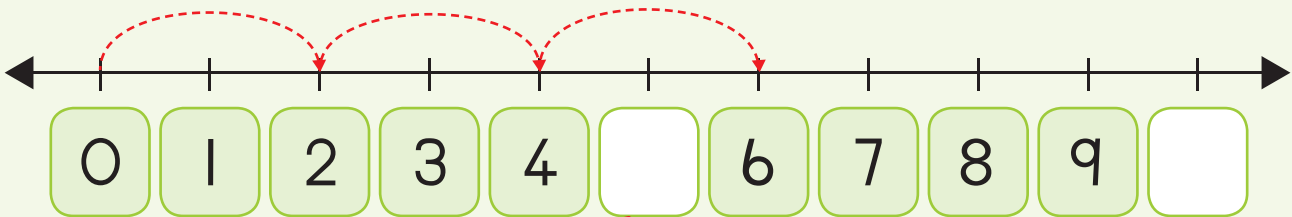

Complete the pattern by colouring the numbers.

1	2	3	4	5	6	7	8	9	10
11	12	13	14	15	16	17	18	19	20

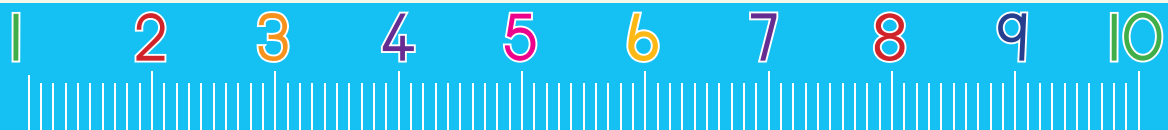



Draw hops to show the following:

0 5 15 20

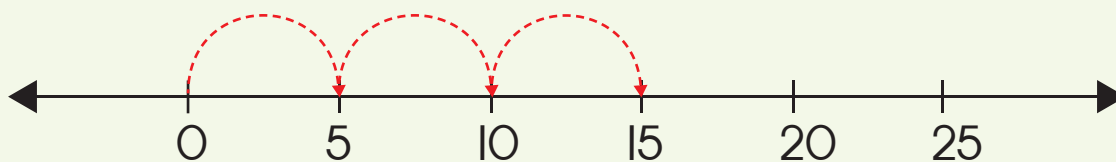

20 25 30 35

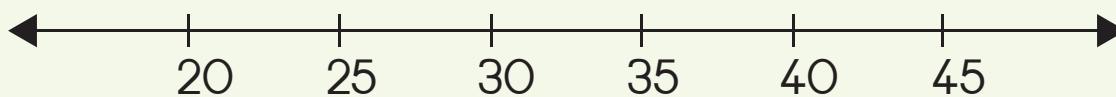

35 40 45 50

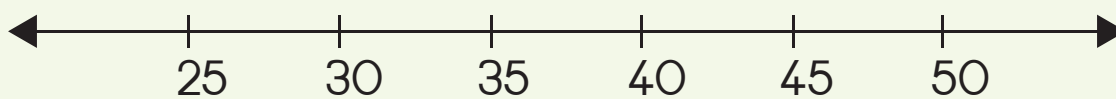

Teacher:
Sign:
Date:





Tens patterns



Fill in the missing numbers.

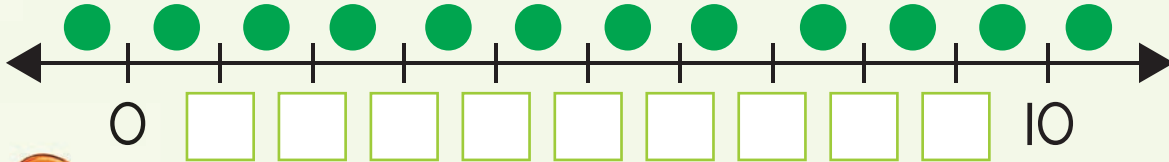

Draw 10 beads between the intervals and match the number to the correct block.

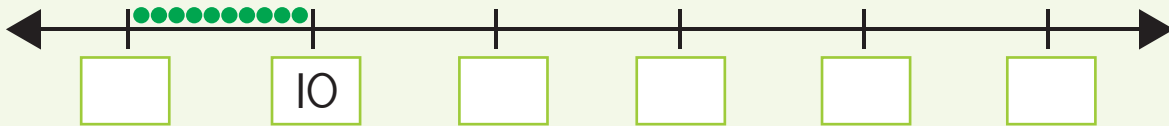

- 50
- 40
- 30
- 20



Complete the number line by copying the given numbers in the correct spaces.

- 50
- 30
- 10
- 0
- 50
- 20
- 40





Complete the number board by using the cut-out numbers.

1	2	3	4	5	6	7	8	9	
11	12	13	14	15	16	17	18	19	
21	22	23	24	25	26	27	28	29	
31	32	33	34	35	36	37	38	39	
41	42	43	44	45	46	47	48	49	
51	52	53	54	55	56	57	58	59	
61	62	63	64	65	66	67	68	69	
71	72	73	74	75	76	77	78	79	
81	82	83	84	85	86	87	88	89	
91	92	93	94	95	96	97	98	99	

Use these cut out numbers from the back of the book.



20	40	10	60	90	80
50	30	100	70		



Teacher:
Sign:

Date:



11 12 13 14 15 16 17 18 19 20

60a

Term 2



Numbers and money

Match the amounts with the money.

R100		
R20		
R10		
5c		
R50		
50c		
R5		
R1		





Money: notes and coins

Circle the notes/coins that has the highest value.

		
 R100	R50	R10

		
RI	R5	R10

		
RI	50c	5c

		
R20	R5	R10



Teacher: _____
 Sign: _____
 Date: _____





Numbers and money (continued)

Circle all the:

5c coins



10c coins



20c coins



Circle all the:

R10 notes



Circle all the:

R20 notes





Circle the coins in each row that will make 20c.



Circle the notes in each row that will make R20.



Teacher:
Sign:

Date:





Money and change

Draw the coins that will give you a total of:

a.

10c

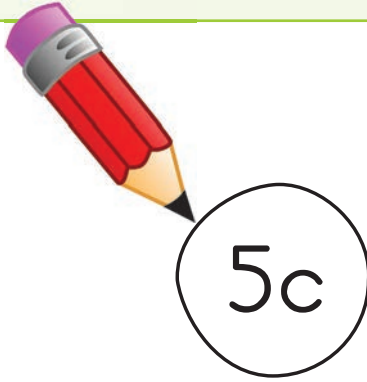

b.

20c

c.

15c

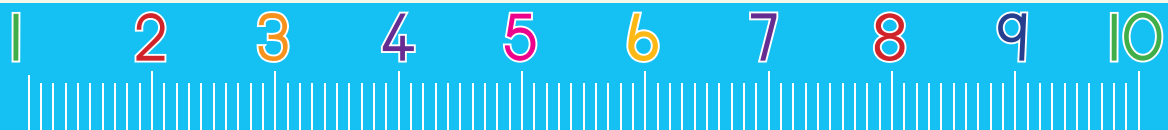



Add the coins. Colour the correct answer.

	10c	15c	20c
	10c	15c	20c
	10c	15c	20c



I have the following in my piggy bank. What can I buy with it. Draw or paste a picture in the block.











Teacher:
Sign:
Date:





More money and change



Take one 5c coin away. How much do you have left?



5c



How much is left?

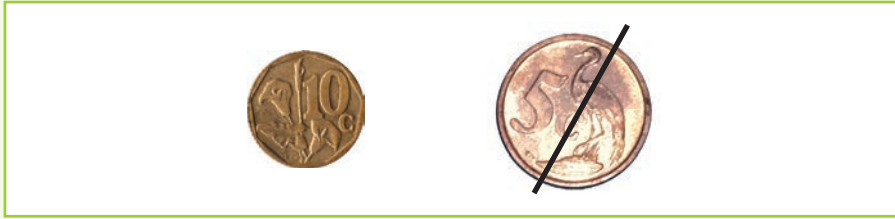
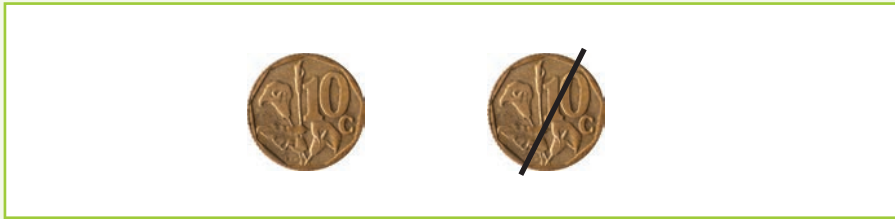



How much is left? Match the following.



5c



20c

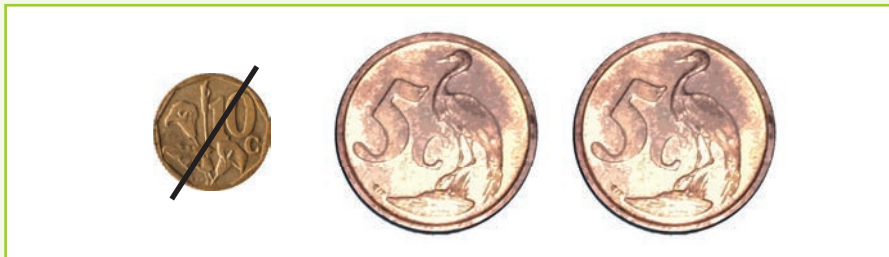

15c

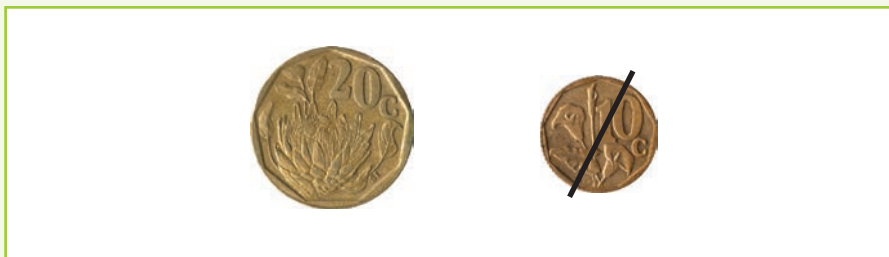

10c



Teacher:
Sign:
Date:



Shape, orientation and position

Find and circle the shape that has the same shape and orientation as the shape in the first box.



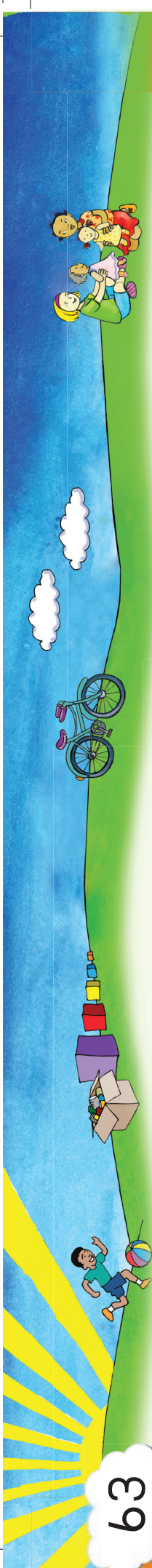

Circle the correct answers.

1	2	3	4	5
Which animal is in front of the elephant?				
Which animal is behind the dog?				
Which animal is between the zebra and the dog?				
If the dog moves forward which animal will it bump into?				
If the elephant moves backward which animal will it bump into?				
Which animal is in the middle of the row?				
Which animal is first in line?				
Which animal is last in line?				

Teacher: _____
 Sign: _____
 Date: _____



Patterns with geometric shapes

Extend the pattern with one more shape.

Red circle, Blue circle, Red circle, Blue circle, Red circle, Blue circle,

Red circle, Red square, Red circle, Red square, Red circle, Red square,

Purple triangle, Purple triangle, Purple triangle, Purple triangle, Purple triangle,

Matchstick, Matchstick, Matchstick, Matchstick, Matchstick, Matchstick, Matchstick, Matchstick, Matchstick, Matchstick, Matchstick, Matchstick, Matchstick, Matchstick, Matchstick, Matchstick,

Yellow circle, Red square, Blue triangle, Yellow circle, Red square, Blue triangle,

Pink rectangular prism, Green cube, Pink rectangular prism, Green cube, Pink rectangular prism, Green cube,



Circle the correct answers.

Yellow circle, Blue triangle, Yellow circle, Blue triangle, Yellow circle, Blue triangle,

Pink square, Blue circle, Pink square, Blue circle, Pink square, Blue circle, Green triangle, Blue circle, Green triangle, Blue circle, Green triangle,

Yellow circle, Blue circle, Yellow circle, Blue circle, Green circle, Blue circle, Green circle,

Blue square, Orange circle, Green triangle, Purple triangle, Orange circle, Blue square,

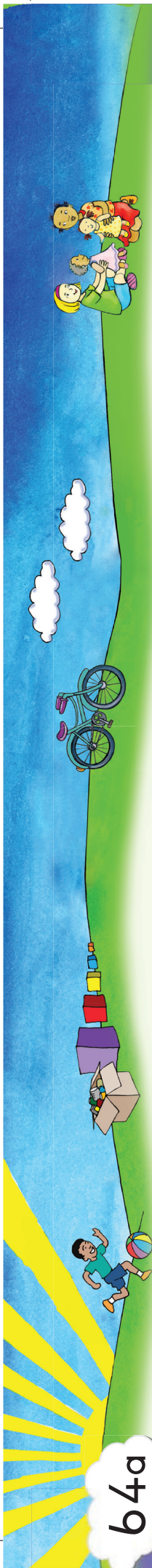

Teacher: _____
 Day: _____
 Date: _____



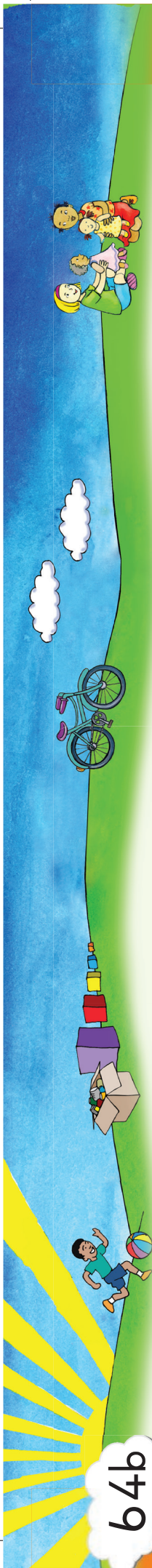



2-D shapes and 3-D objects



Colour the shapes.

Colour the squares  red.

Colour the circles  blue.

Colour the triangles  green.

Colour the boxes  yellow.

Colour the balls  purple.

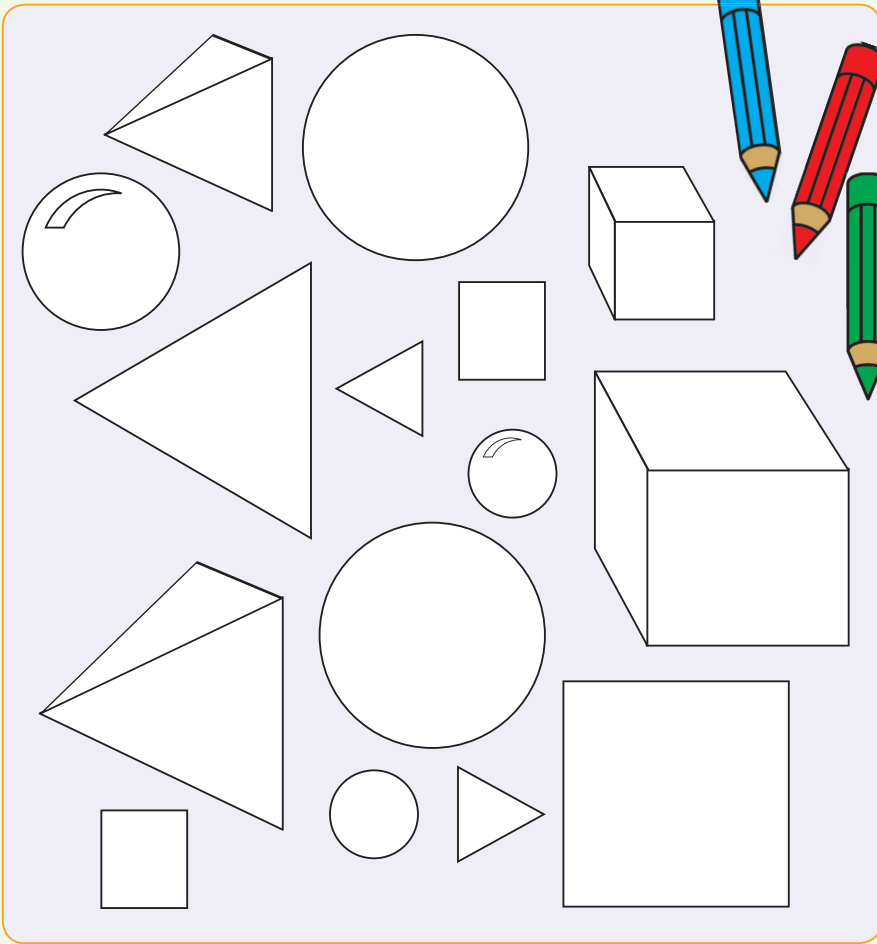

Colour the pyramids  orange.







Shapes and solid objects



Circle the bodies.

Circle this  in red. 

Circle this  in blue. 

Circle this  in green. 

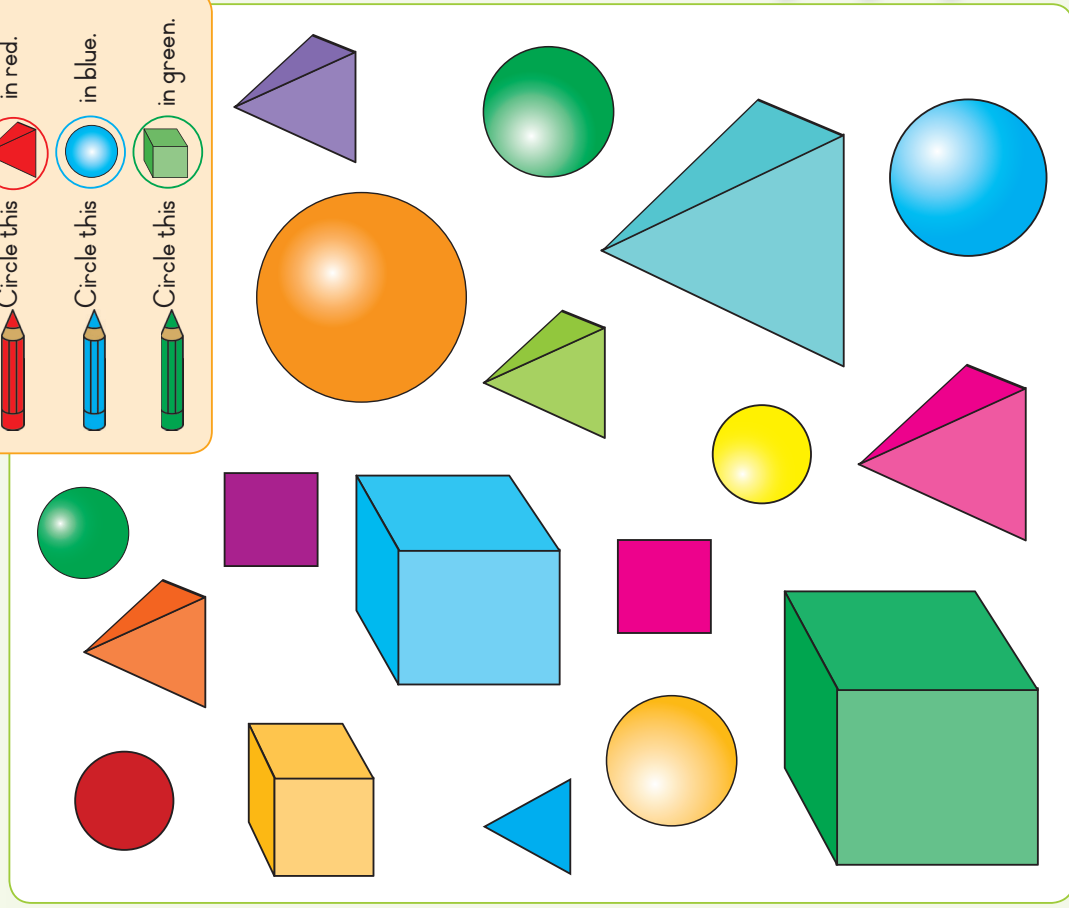

Teacher: _____
 Day: _____
 Date: _____





Shapes:

Cut out the shapes on the dotted lines. Now use them to do the worksheets in your book. Remember to keep them safe so that you can use them over and over again.

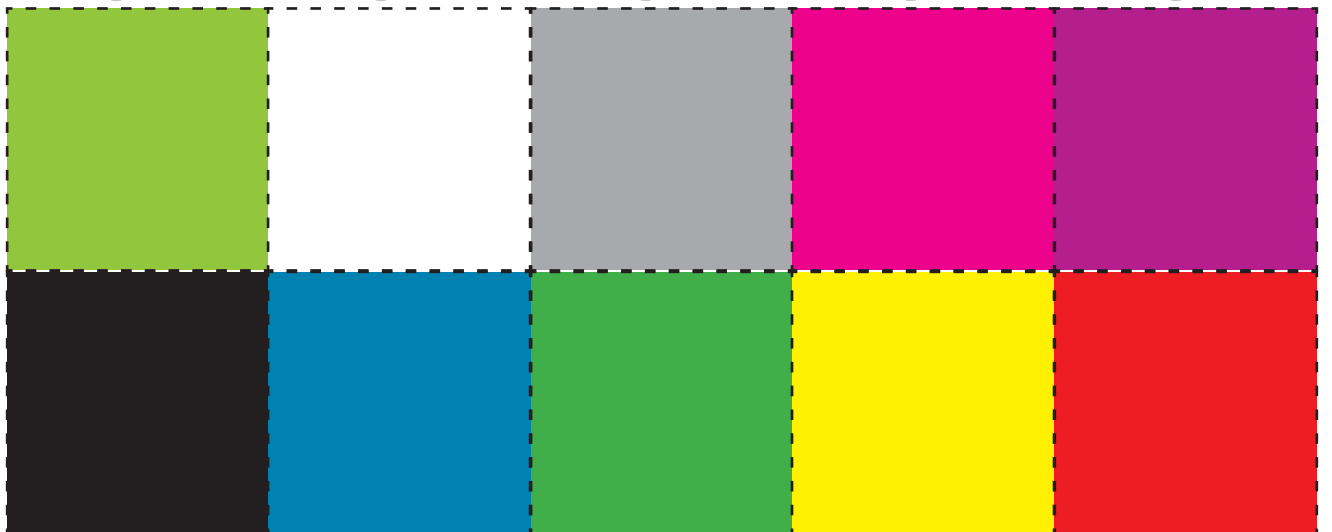
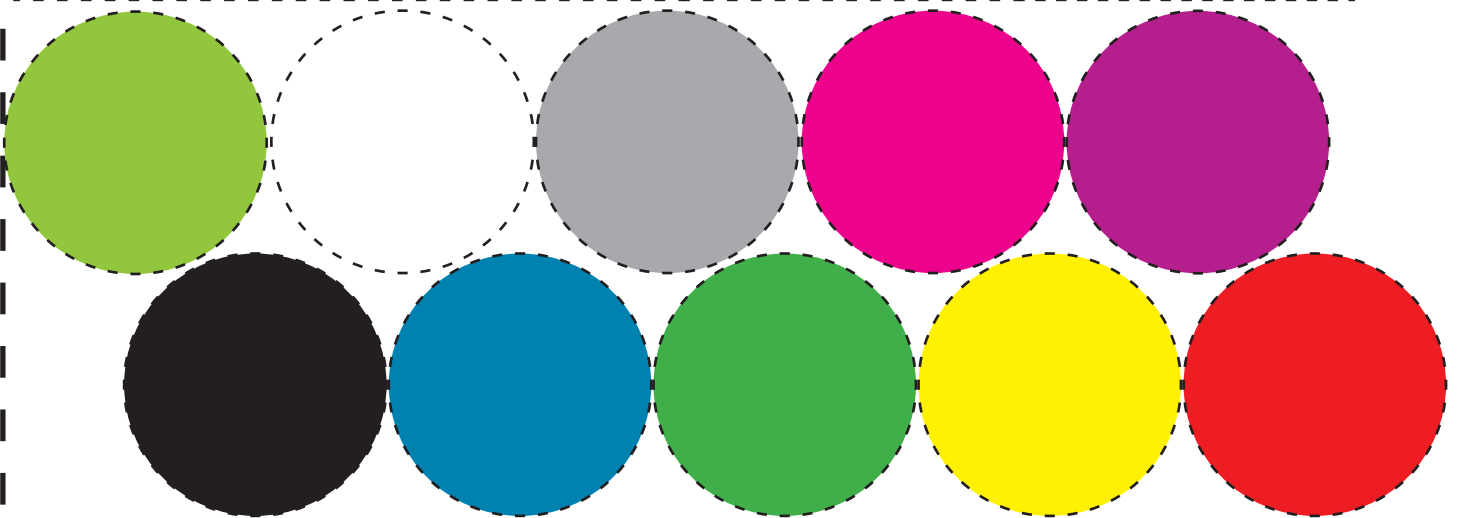
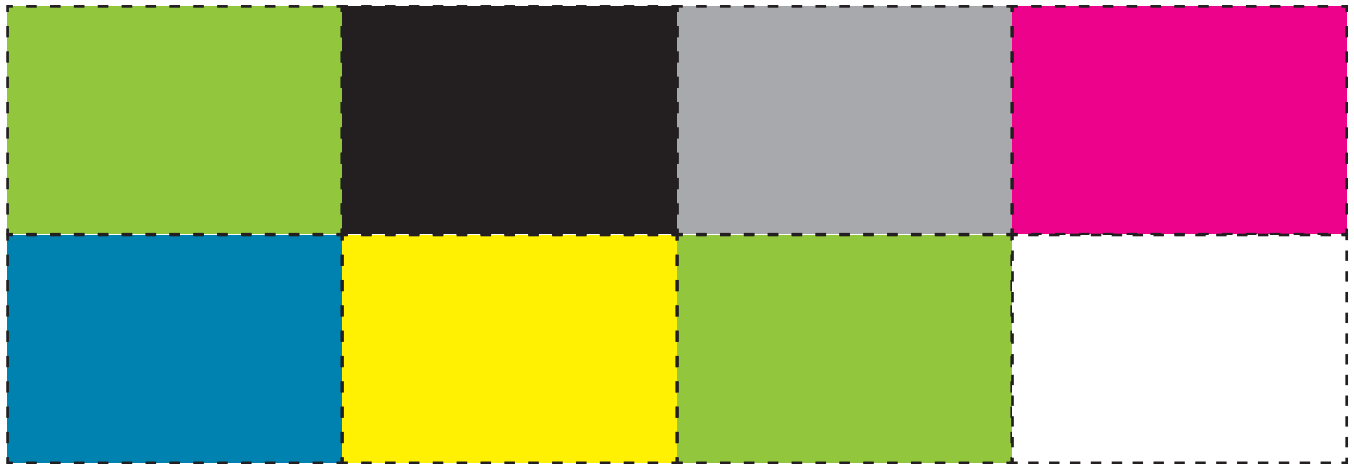
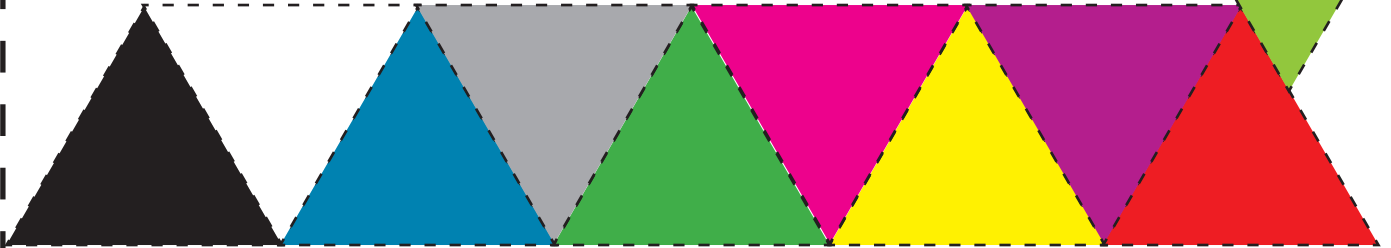

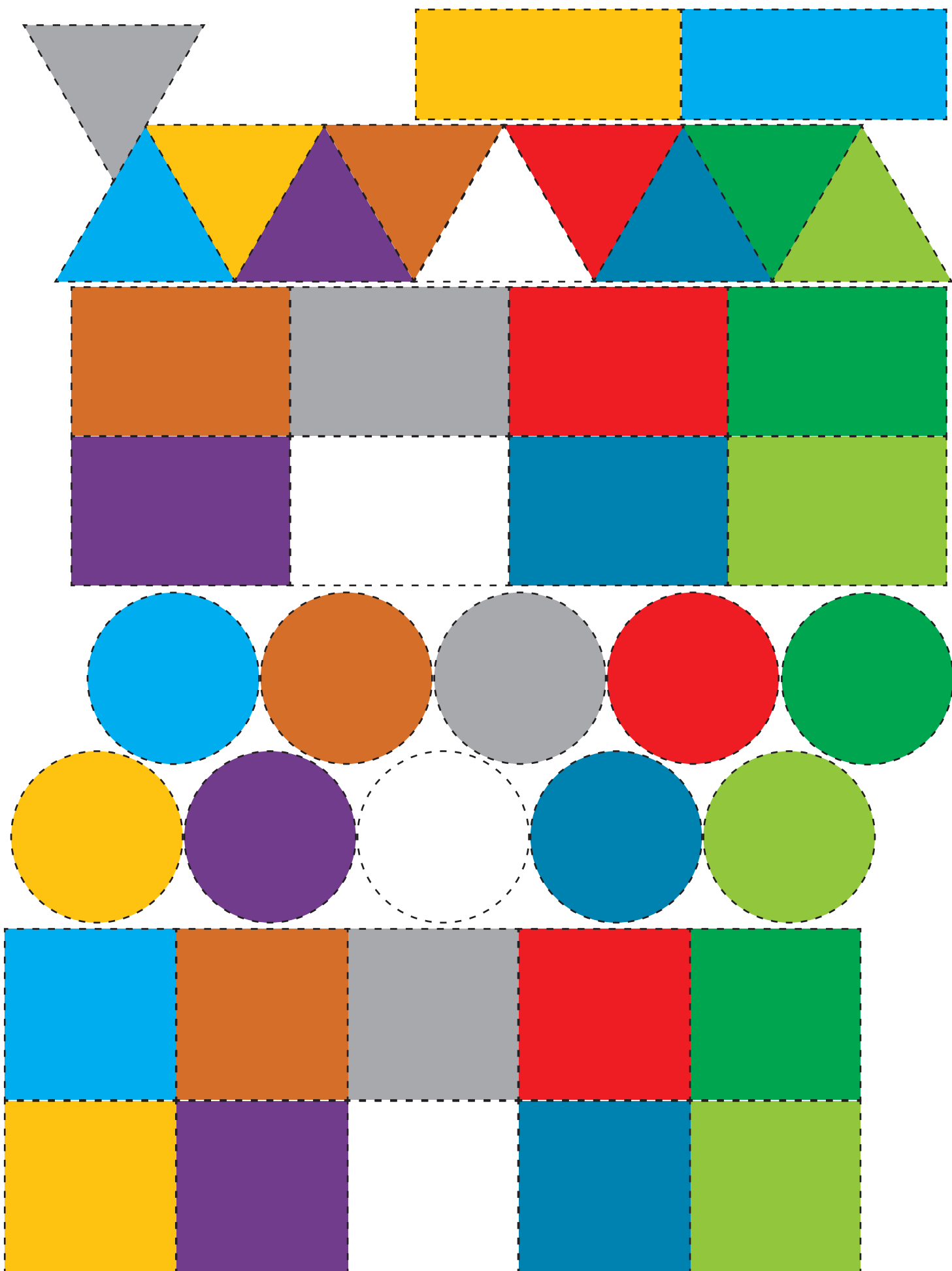

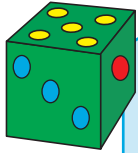

Make a dice:

Cut the dice out on the black outer line and fold on the white dotted lines. Glue the flaps to the inside of the dice.

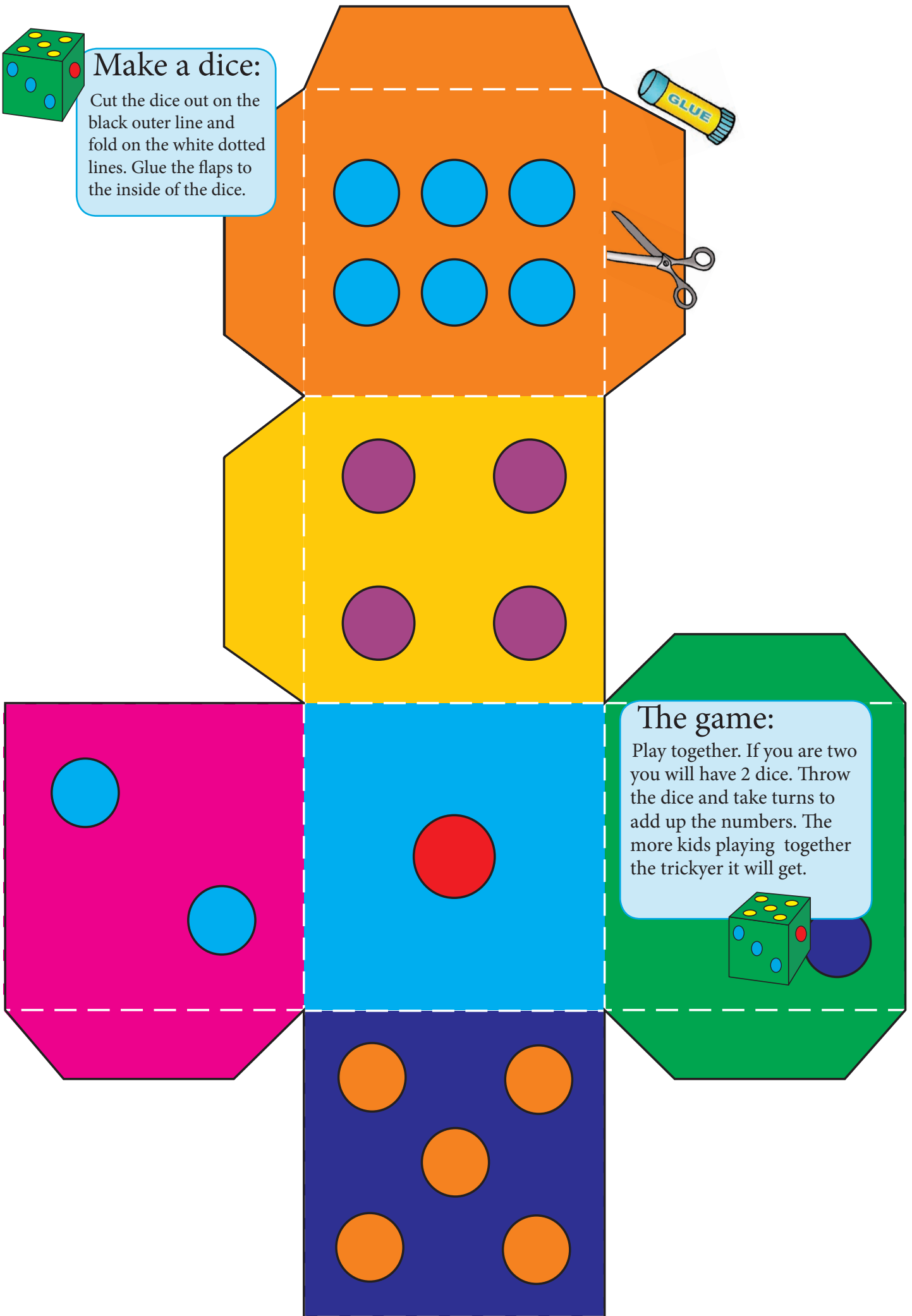

The game:

Play together. If you are two you will have 2 dice. Throw the dice and take turns to add up the numbers. The more kids playing together the trickier it will get.

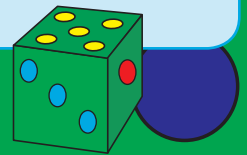

Use these cut outs numbers to complete the number board.

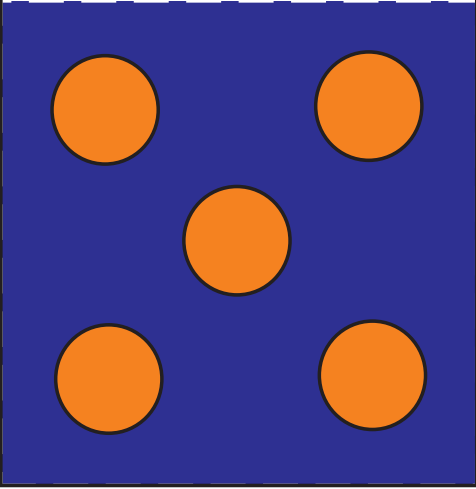
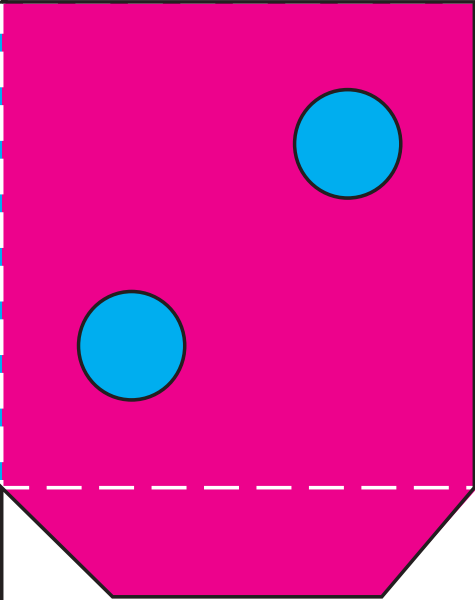
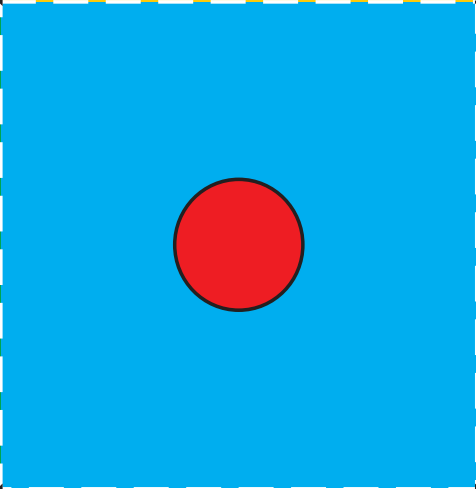
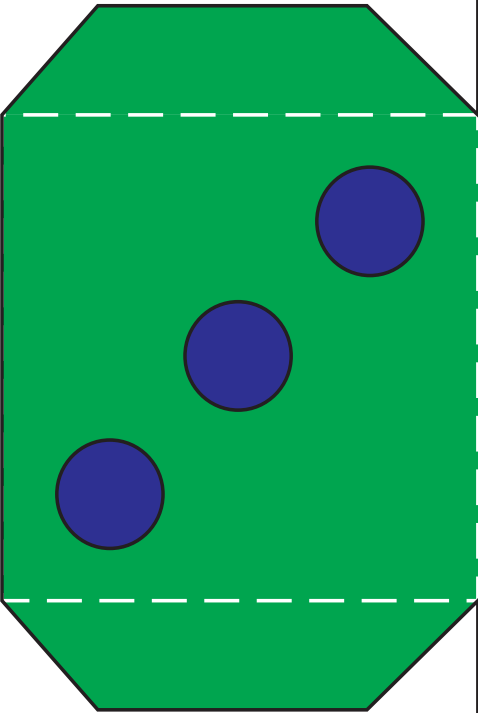
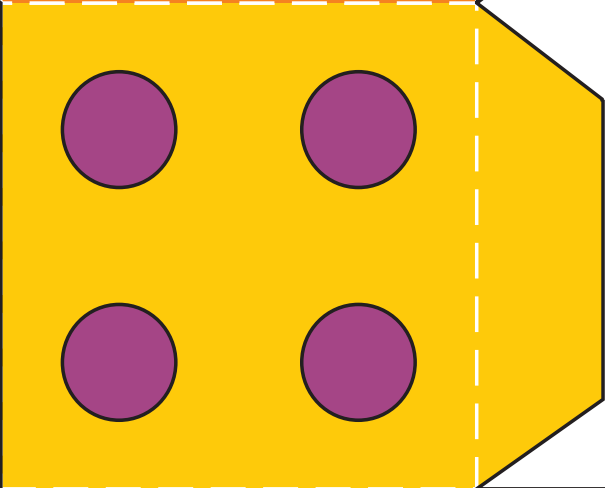
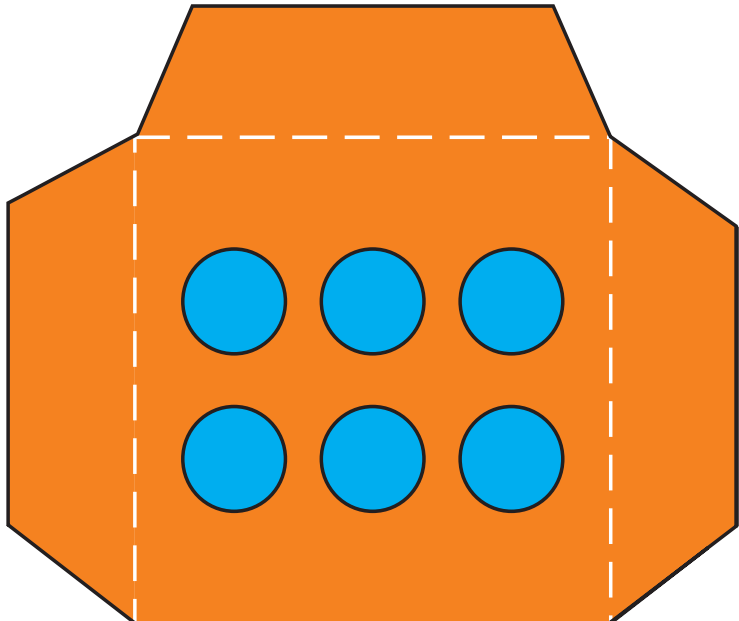

20	40
10	60
90	80
50	30
100	70